

KITCHEN  
COLLECTION



HEART OF  
YOUR HOME



# HERZLICH WILLKOMMEN

## IM HERZEN IHRES ZUHAUSES

In Ihrer Küche ist Platz für jede Menge Geborgenheit und Komfort nach Maß. Im Herzen des Hauses bündelt sich, was Ihnen lieb und teuer ist. Wenn das Kochen zum Vergnügen wird, ist alles perfekt an Ihre Ansprüche angepasst. Und weil es so behaglich ist, versammeln sich Ihre Gäste am liebsten hier. Was auch immer Sie sich vorstellen, mit unseren Küchen werden Ihre Wünsche wahr.

## *WELCOME TO THE HEART OF YOUR HOME*

Your kitchen is a place to feel at home in and provide bespoke practical convenience. The heart of the home, this is where everything you hold dear comes together. When cooking turns into a pleasure, everything needs to meet your expectations with a level of perfection second to none. And because it's all so welcoming, this is where your guests like to gather most. No matter what you picture, our kitchens make your wishes come true.

## *HARTELIJK WELKOM IN HET HART VAN UW HUIS*

In uw keuken is ruimte voor veel geborgenheid en comfort op maat. Het hart van het huis is waar alles wat je dierbaar is samenkomt. Wanneer koken een plezier wordt, is alles perfect aangepast aan uw behoeften. En omdat het zo knus is, is dit de plek waar uw gasten het liefst samenkomen. Wat uw wensen ook zijn, met onze keukens komen uw ideeën tot leven.

## *BIENVENUE AU CŒUR DE VOTRE MAISON*

Votre cuisine offre suffisamment de place pour une ambiance cocooning et un confort sur mesure. Le cœur de la maison regroupe tout ce qui vous est cher. Si cuisiner devient un plaisir, c'est que tous vos souhaits sont comblés. Elle est si accueillante que vos invités aiment se retrouver en ce lieu. Quel que soit votre souhait, nos cuisines le réalisent.



MICHAEL ASSNER



SABINE BROCKSCHNIEDER



MATTHIAS BERENS

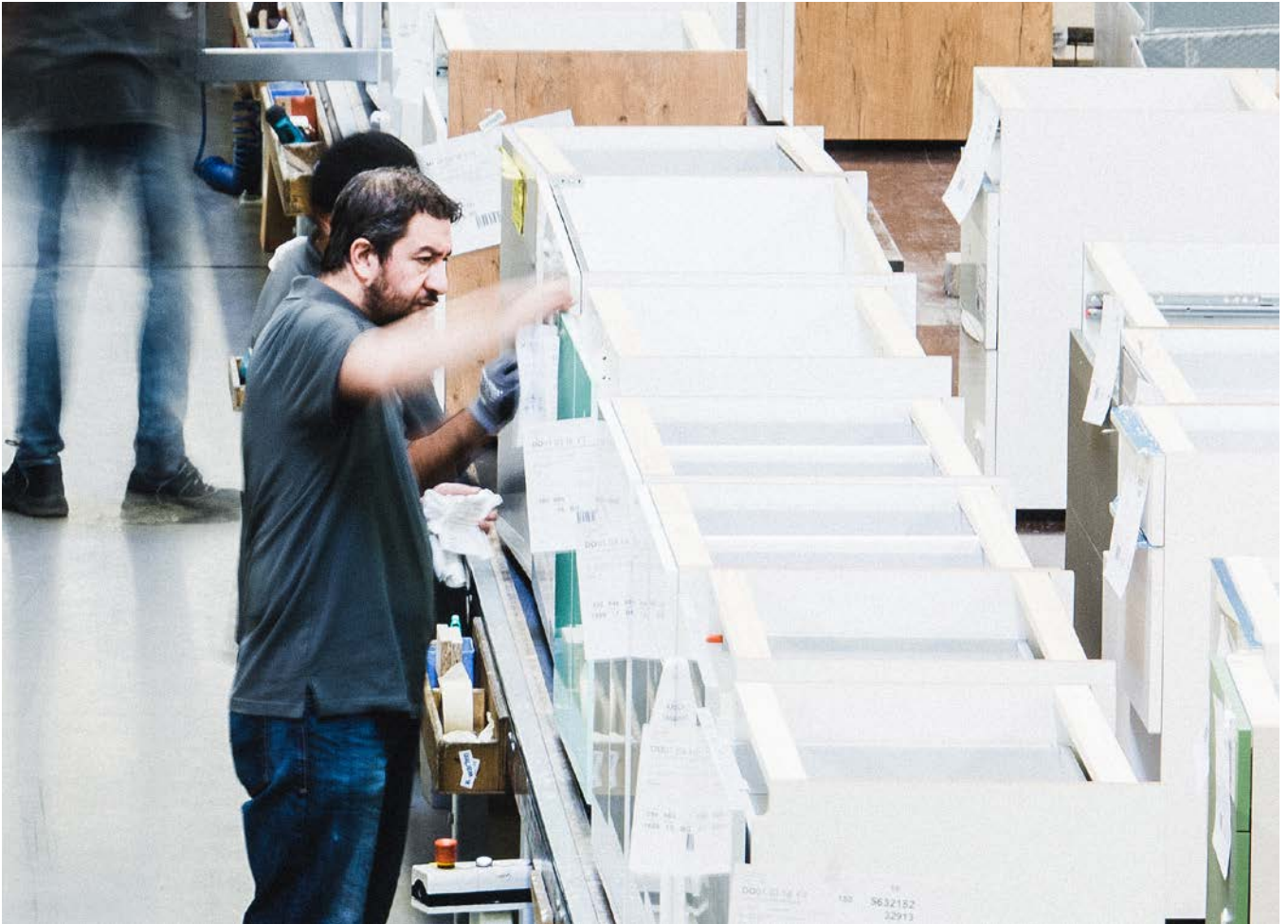

# EINE FAMILIE, EIN ZIEL

1917 gegründet, hat sich unser Unternehmen mit mehr als 100 Jahren Erfahrung als international tätige Gruppe und feste Größe im Küchenmarkt etabliert. Unsere Mitarbeiter sind die Wurzel unseres Erfolgs, der auf einer Vier-Marken-Strategie basiert: Die Küchen von BAUFORMAT und burger decken den Marktbereich vom Einstiegsmodell bis zum Premium-Segment ab. BURG ist für Elektrogeräte in bester Qualität und die Marke badea als Synonym für individuelle Badmöbel bekannt.

## *ONE FAMILY, ONE GOAL*

Founded in 1917, our company can look back on over 100 years of experience as an international group and established name in the kitchen market. Our members of staff are the bedrock of our success which is based on a four-brand strategy: kitchens from BAUFORMAT and burger cover the entire market spectrum from entry-level model to premium segment. BURG is renowned for top-quality electrical appliances, with the badea brand being synonymous with individually tailored bathroom furniture.

## *ÉÉN FAMILIE, ÉÉN DOEL*

Onze onderneming werd in 1917 opgericht en heeft zich met meer dan 100 jaar ervaring als internationaal actieve groep en als constante factor binnen de keukenmarkt gevestigd. Onze medewerkers vormen de basis van ons succes, dat gebaseerd is op een vier-merken-strategie: de keukens van BAUFORMAT en burger dekken de markt van instapmodel tot premiumsegment af. BURG staat bekend om de beste kwaliteit elektrische apparatuur en het merk badea is synoniem met individuele badkamermeubels.

## *UNE FAMILLE, UN OBJECTIF*

Fondée en 1917, notre entreprise, forte d'une expérience de plus de 100 ans, s'est positionnée comme un groupe international et bénéficie d'une grande notoriété sur le marché des cuisines. Nos employés sont à l'origine de notre succès, basé sur la stratégie « Quatre Marques » : les cuisines BAUFORMAT et burger permettent de couvrir l'ensemble des segments de marché, de l'entrée au haut de gamme. BURG propose de l'électroménager d'excellente qualité et badea invite à créer la salle de bains de rêve.

# UNSERE MAXIME: QUALITÄT

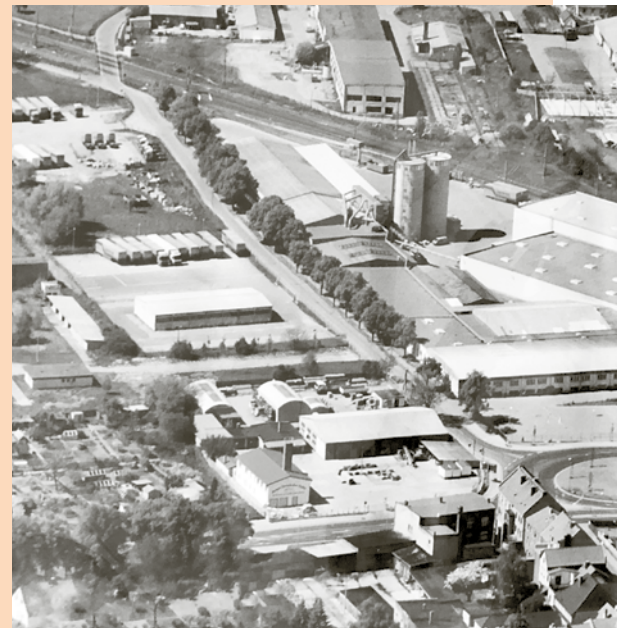

Das Markensiegel »MADE IN GERMANY« steht für weit mehr als nur unsere Herkunft und unseren Produktionsort. German Quality gilt in allen Produktionsbereichen unserer Unternehmensgruppe als Maßstab und oberste Maxime. Zeitgemäße Maschinenfertigung und hohe Umweltstandards verbinden sich mit handwerklichem Können zu einem hochautomatisierten Arbeitsprozess. Schließlich ist jede der Küchen, die Tag für Tag unsere Werke verlassen, ein Unikat nach Maß, für dessen Qualität wir uns verbürgen.

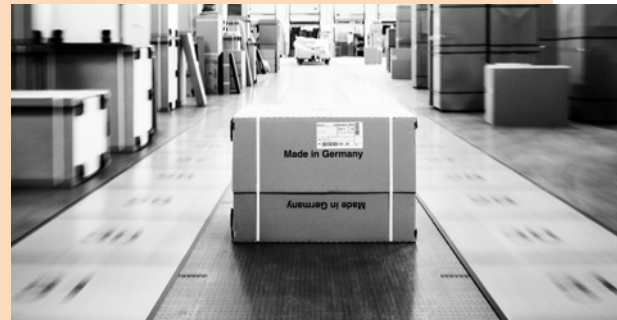

# 1917

## OUR MAXIM: QUALITY

The hallmark "MADE IN GERMANY" represents much more than just our roots and our manufacturing base. German Quality is the yardstick and overriding maxim in all areas of production within our company group. State-of-the-art mechanical production and high environmental standards are coupled with skilled craftsmanship to create a highly automated work process. After all, day after day, every kitchen to leave our factories is a bespoke product, the quality of which we guarantee.



## ONS MOTTO: KWALITEIT

Ons keurmerk 'MADE IN GERMANY' gaat voor ons veel verder dan onze herkomst en de productieplaats. German Quality is de norm en ons ultieme motto in alle productieafdelingen van onze ondernemingsgroep. Moderne industriële productie en hoge milieunormen in combinatie met ambachtelijke vaardigheden zorgen voor een verregaand geautomatiseerd arbeidsproces. Tenslotte zijn alle keukens die onze fabrieken dagelijks verlaten uniek, met een door ons gegarandeerde hoge kwaliteit.

## NOTRE MAXIME : QUALITÉ

Pour nous, le label « MADE IN GERMANY » va bien au-delà de notre origine et de notre site de production. German Quality à tous les échelons de notre Groupe, telles sont nos références et maximes. Un parc de machines moderne et de sévères normes environnementales associés à un savoir-faire artisanal pour aboutir à un travail largement automatisé. Car chaque cuisine, qui quitte jour après jour nos usines, est une pièce unique dont nous garantissons la qualité.



# GOLDENE M



Das „Goldene M“ der Deutschen Gütegemeinschaft Möbel e. V. gilt als strengster Qualitätsnachweis für Möbel in Europa und ist in diesem Bereich das einzige RAL-Gütezeichen in Deutschland. Unsere Möbel werden regelmäßig von unabhängiger Stelle geprüft. Das „Goldene M“ garantiert Ihnen die hohe Qualität unserer Küchen und steht für gesundes Wohnen.

## GOLDEN M

The "Golden M" from the German Furniture Quality Assurance Association (Deutsche Gütegemeinschaft Möbel e.V. - DGM) is regarded as the most stringent proof of quality for furniture in Europe and is Germany's only RAL quality label in this segment. Our furniture undergoes regular inspection by an independent body. In other words, the "Golden M" guarantees you the high quality of our kitchens and also provides a key to healthy home living.

## GOUDEN M

De 'Gouden M' van de Deutsche Gütegemeinschaft Möbel e.V. wordt beschouwd als het strengste bewijs van kwaliteit voor meubels in Europa en is op dit gebied het enige RAL-kwaliteitskeurmerk van Duitsland. Onze meubels worden regelmatig door onafhankelijke instanties gecontroleerd. De 'Gouden M' garandeert u de hoge kwaliteit van onze keukens en staat voor een gezonde leefomgeving.

## « GOLDENE M »

Le « Goldene M », décerné par le Groupement allemand de Qualité des meubles [Deutsche Gütegemeinschaft Möbel e.V., DGM], est une preuve de qualité irréfutable pour les meubles en Europe et, dans ce domaine, le seul label RAL en Allemagne. Nos meubles sont régulièrement contrôlés par un organisme indépendant. Le « Goldene M » est donc le gage de qualité de nos cuisines et d'habitat sain.

---

# MADE IN GERMANY



**Wir verbinden anerkannte Markenqualität mit jahrzehntelanger Erfahrung und einer verantwortungsvollen Planung, Gestaltung und Fertigung in Deutschland. In Ostwestfalen-Lippe präsentiert sich die Marke im Rahmen einer großzügigen Dauerausstellung für Fachhandelspartner und Interessierte.**

We combine acknowledged brand quality with decades of experience and responsible planning, design and production in Germany. The brand is presented in Ostwestfalen-Lippe in a spacious permanent exhibition for specialist retail partners and prospective customers.

Wij combineren erkende merkkwaliteit met decennialange ervaring en een verantwoorde planning, ontwerp en productie in Duitsland. In Oostwestfalen-Lippe presenteert het merk zich in een ruim opgezette, permanente tentoonstelling voor gespecialiseerde handelspartners en belangstellenden.

Nous allions qualité éprouvée et savoir-faire de plusieurs décennies et nous engageons pour une planification, un agencement et une fabrication responsables en Allemagne. C'est au cœur de la région Westphalie Est-Lippe que se présente la marque dans le cadre d'une grande exposition permanente s'adressant aux revendeurs et aux prospects.

# GEPRÜFTE SICHERHEIT



Mit dem weltweit anerkannten GS-Zeichen stellen wir sicher, dass unsere Produkte die Qualitäts- und Sicherheitsstandards des deutschen Produktsicherheitsgesetzes (kurz ProdSG) erfüllen.

Das GS-Siegel ist für Sie eine wertvolle Entscheidungshilfe beim Kauf. Auf die Qualität und Sicherheit unserer Produkte können Sie sich verlassen.



## TESTED SAFETY

With the internationally acknowledged GS label of tested safety, we ensure that our products meet the quality and safety standards of the German Product Safety Act (in short ProdSG).

The GS label provides you with valuable assistance in deciding which product to buy. You can rely on the quality and safety of our products.

## GECONTROLEERDE VEILIGHEID

Met het wereldwijd erkende GS-teken zorgen wij ervoor, dat onze producten voldoen aan de kwaliteits- en veiligheidsnormen van de Duitse productveiligheidswet (afgekort: ProdSG).

Het GS-teken is voor u een waardevolle hulp bij uw beslissing om een keuken aan te schaffen. U kunt altijd vertrouwen op de kwaliteit en veiligheid van onze producten.

## « GEPRÜFTE SICHERHEIT » [GS, SÉCURITÉ CERTIFIÉE]

Le label GS, de réputation internationale, nous permet de garantir que nos produits sont conformes aux exigences en termes de qualité et de sécurité prescrites par la loi allemande sur la sécurité des produits [Produktsicherheitsgesetz, ProdSG].

Pour vous, le label GS est une aide précieuse à l'achat. Vous pouvez compter sur la qualité et la sécurité de nos produits.

---

# EMISSIONSKLASSE UND CARB2



Unsere Span- und MDF-Platten sind besonders emissionsarm. Wir halten die US-Vorgaben nach TSCA Title VI ein, die noch strenger sind als die Vorgaben in Europa.

## EMISSION CLASS AND CARB2

Our chipboard and MDF boards are particularly low in emission. We meet the US requirements defined in TSCA Title VI, which are even stricter than the requirements in Europe.

## EMISSIEKLASSE EN CARB2

Onze spaan- en MDF-platen zijn bijzonder emissiearm. Wij voldoen aan de Amerikaanse eisen van TSCA Title VI, die nog strenger zijn dan de eisen in Europa.



## CLASSEMENT AUX FORMALDÉHYDES ET CARB2

Nos panneaux de particules et MDF se distinguent par leurs vertus non polluantes. Nous respectons les spécifications américaines TSCA Title VI, encore plus strictes que la réglementation européenne.



# NACHHALTIG IN DIE ZUKUNFT



## PEFC

Unsere Unternehmensgruppe ist PEFC-zertifiziert. Damit ist garantiert, dass die Rohstoffe für unsere Küchen- und Badmöbel ausschließlich aus nachhaltig bewirtschafteten Wäldern stammen.

*PEFC*  
Our company group holds PEFC certification. This guarantees that the raw materials for our kitchen and bathroom furniture only come from sustainably managed forests.

*PEFC*  
Onze ondernemingsgroep is PEFC-gecertificeerd. Hierdoor wordt gegarandeerd dat de grondstoffen voor onze keuken- en badkamermeubels uitsluitend worden vervaardigd van hout afkomstig uit duurzaam beheerde bossen.

*PEFC*  
Notre Groupe est certifié PEFC. Le garant que le bois entrant dans la fabrication de nos cuisines et salles de bains provient exclusivement de forêts gérées durablement.



## BLAUER ENGEL

Unsere Möbel tragen den Blauen Engel. Denn die Holzwerkstoffe stammen aus nachhaltiger Forstwirtschaft, werden emissionsarm produziert und weiterverarbeitet und sind gesundheitlich unbedenklich.

*BLUE ANGEL*  
Our furniture carries the Blue Angel label. Because the wood-based materials are sourced from sustainable forestry, produced and processed with low emissions and harmless to health.

*BLAUWE ENGEL*  
Onze meubels zijn voorzien van het keurmerk 'Blauer Engel'. Want de houtmaterialen stammen uit duurzaam beheerde bossen, worden emissiearm geproduceerd en verder verwerkt en zijn onschadelijk voor de gezondheid.

« *BLAUER ENGEL* »  
Nos meubles portent le label Blauer Engel [Ange bleu]. Car les bois utilisés proviennent de sylviculture durable, nos meubles sont fabriqués et façonnés de manière non polluante et sont absolument sans danger pour la santé.



Unsere Möbelstücke tragen das bekannteste deutsche Umweltzeichen, den Blauen Engel. Wir setzen ausschließlich auf emissionsarme Lacke und Holzwerkstoffe aus nachhaltiger Forstwirtschaft. Die meisten unserer Lieferanten kommen aus unserer Region und wirtschaften nach vergleichbaren Umweltstandards wie wir. Digitalisierte Prozesse zur Papierersparnis und eine klimaschonende Logistik mit LKW der EURO 6-Norm, Hybridfahrzeugen und hauseigenen E-Tankstellen sind Bausteine unseres Nachhaltigkeitskonzeptes.

#### ON THE WAY TO A SUSTAINABLE FUTURE

Our furniture carries Germany's best-known environmental label, the Blue Angel. We only use low-emission lacquers and wood-based materials from sustainable forestry. Most of our suppliers come from our region and operate with environmental standards comparable to those of our own. Paper-saving digitised processes and climate-friendly logistics with EURO 6 lorries, hybrid vehicles and our own in-house recharging stations are key elements of our sustainability concept.

#### DUURZAAM DE TOEKOMST TEGEMOET

Onze meubels zijn voorzien van het bekendste Duitse milieulabel: Blauer Engel. Wij maken uitsluitend gebruik van emissiearme lak en houtmaterialen uit duurzame bosbouw. De meeste van onze leveranciers komen uit onze regio en werken volgens milieunormen die vergelijkbaar zijn met de onze. Gedigitaliseerde processen voor het besparen van papier en een klimaatvriendelijke logistiek met EURO 6-standaard vrachtwagens, hybride voertuigen en eigen elektrische laadstations zijn bouwstenen van ons duurzaamheidsconcept.

#### DURABILITÉ POUR L'AVENIR

Nos meubles portent le label Blauer Engel [Ange bleu], le plus célèbre label environnemental allemand. Nous utilisons exclusivement des vernis non polluants et des bois issus de sylviculture durable. La plupart de nos fournisseurs sont de notre région et appliquent des normes environnementales comparables aux nôtres. Notre concept de durabilité est basé sur des processus numériques afin d'économiser du papier et une logistique respectueuse de l'environnement avec des poids lourds classés selon la norme d'émission Euro 6, des véhicules hybrides et nos bornes de recharge pour voitures électriques.



#### RKT

Unsere Verpackungen werden vom Recycling Kontor dem Kreislauf des Dualen Systems zugeführt und die Materialien verantwortungsvoll wiederverwertet.

#### RKT

The Cologne-based Recycling Kontor Transportverpackungen GmbH channels our shipping packages into Germany's "Dual System" of waste management, with the materials recovered being recycled in a responsible manner.

#### RKT

Onze verpakkingen worden door de firma Recycling Kontor in de kringloop van het Dual System gebracht en de materialen worden op verantwoordelijke wijze hergebruikt.

#### « RKT »

Nos emballages sont collectés par l'entreprise Recycling Kontor et les matériaux recyclés sont réutilisés.



#### KLIMANEUTRALES UNTERNEHMEN

Die Geschäftsführung und das gesamte Team setzen sich zum Ziel, für zukünftige Generationen eine intakte Umwelt zu erhalten. Deshalb leisten wir einen zuverlässigen Beitrag zum Klimaschutz.

#### CLIMATE NEUTRAL BUSINESS

The management and the entire team have set themselves the goal of preserving an intact environment for future generations. It is in this way that we make a reliable contribution to protecting our climate.

#### KLIMAATNEUTRALE ONDERNEMING

De directie en het gehele bedrijfsteam hebben zich ten doel gesteld om toekomstige generaties een intact milieu na te laten. Daarom leveren wij een blijvende bijdrage aan de milieubescherming.

#### ENTREPRISE CLIMATIQUEMENT NEUTRE

La direction et toute l'équipe se sont fixées pour objectif de préserver l'environnement pour les générations futures. C'est pourquoi nous nous engageons pour le climat.



**Leni Paula**

6



**Cora Susann**

26



**Mara**

52



**Leni Amelie**

10



**Amelie**

32



**Sophie**

54



**Susann**

14



**Amelie**

46



**Sophie Jette**

60



**Cora Cindy**

20



**Jette Amelie**

50



**Mara**

64



**Jette**

70



**Cindy Leni**

88



**Amelie Susann** 104



**Cindy**

76



**Lara**

90



Nischenmotive  
Recess motifs  
Nismotieven  
Motifs crédence

110



**Cindy**

78



**Cindy**

98



Fronten | Front Panels  
Fronten | Façades

114



**Cora Cindy**

84



**Celine Jette**

100



Griffe | Handles  
Grepn | Poignées

125

# FÜR GEMEINSAME MOMENTE

*FOR SHARED MOMENTS  
VOOR GEZAMENLIJKE MOMENTEN  
DU BONHEUR À PARTAGER*





WELCOME  
TO THE  
KITCHEN  
FAMILY



LENI

PAULA

DARK GROOVE

SCHWARZ SEIDENMATT



# SINN FÜR DESIGN

*DESIGN SENSE  
GEVOEL VOOR DESIGN  
LE SENS DU DESIGN*

**Eleganz darf funktional sein! Unsere widerstandsfähige Schichtstoff-Front Paula zeigt sich robust und in seidigem Schwarz. Praktischer Bonus: eine Anti-Fingerprint-Beschichtung gegen Fingerabdrücke.**



Let elegance be practical too! Our hard-wearing Paula laminate front is robust and comes in silky matt black. Practical bonus: anti-fingerprint coating to keep finger marks at bay.

Elegantie mag functioneel zijn! Ons slijtvaste laminaatfront Paula is robuust en wordt geleverd in zwart zijdemat. Handige bonus: anti-fingerprint-coating tegen vingerafdrukken.

Élégance rime avec fonctionnalité ! Notre façade Paula en stratifié, résistante et robuste, se distingue par son fini noir mat soyeux. Son atout pratique : un revêtement anti-traces de doigts.





**Modernes Stilmittel: Die Rillenstruktur unserer Front Leni ist angesagt. Kein Wunder, harmoniert sie doch prächtig mit Licht und kontrastierten Elementen.**



Expression of modern style: the grooved structure on our Leni front is so hip. No wonder, because it harmonises so beautifully with light and contrasting elements.

Modern stijlmiddel: de gegroefde structuur van ons front Leni is helemaal in. Geen wonder, want het harmonieert prachtig met licht en contrasterende elementen.

Une icône du style : la structure rainurée de notre façade Leni est au goût du jour. Rien d'étonnant puisqu'elle s'harmonise merveilleusement bien avec l'éclairage et les éléments contrastants.







LENI AMELIE

DARK GROOVE SAND



## TRENDSETTER MIT KLARER IDEE

Die Rille liegt im Trend: Wenn sich Linie an Linie reiht, entstehen Tiefeneffekte mit einzigartiger Wirkung. Vollendung findet die Rillenoptik in unserer hochwertigen Melaminharz-Front Leni. Beide Dekore ermöglichen zeitgemäße Planungen zu attraktiven Konditionen - und eine Linienstruktur in der Küche, die neue Maßstäbe an Design setzt.

# LENI

## *TRENDSETTER WITH A CLEAR IDEA*

Grooves are all the trend: lined up in rows, they create a sense of depth with unique effect. Our high-quality melamine resin Leni front takes the grooved look to perfection. Both decor finishes provide contemporary planning options on attractive terms - while bringing linear structure to the kitchen that sets new design standards.

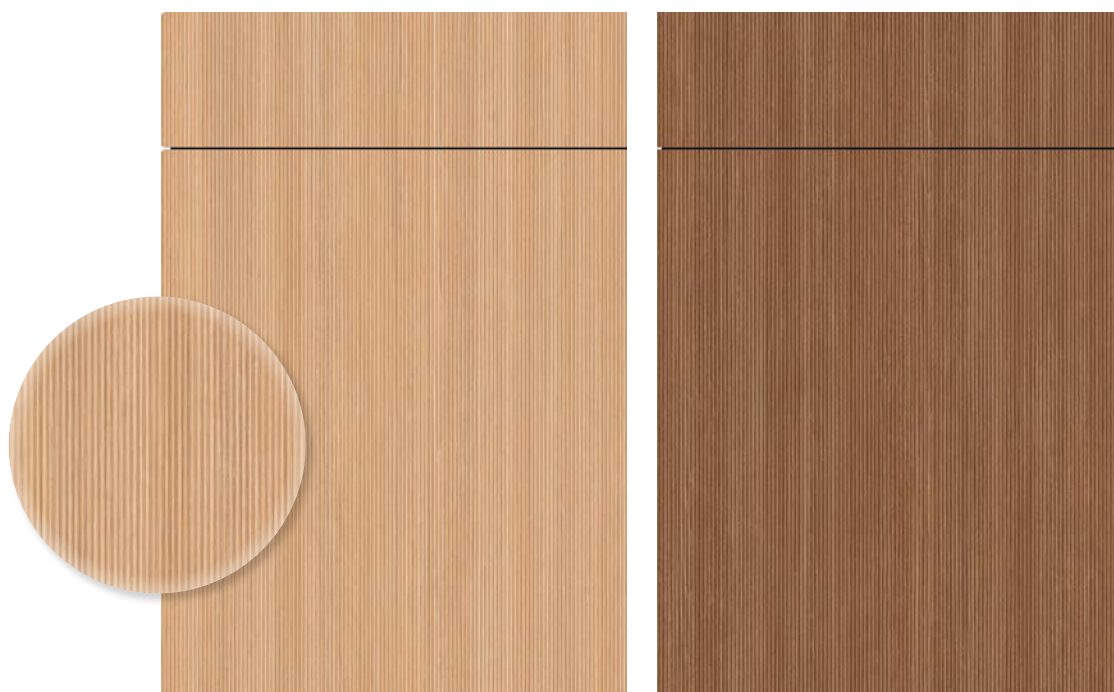

LENI 188  
Soft Groove

LENI 189  
Dark Groove

## *TRENDSETTER MET EEN HELDER IDEE*

De groef is trendy: wanneer lijn naast lijn mooi doorloopt, ontstaan diepte-effecten met een unieke impact. De gegroefde look werd bij ons hoogwaardige melamineharsfront Leni geperfectioneerd. Beide decors maken een eigentijdse planning mogelijk tegen aantrekkelijke voorwaarden - en een lijnenspel in de keuken dat nieuwe normen stelt op het gebied van design.

## *DANS L'AIR DU TEMPS*

Les rainures sont très tendance : alignées, elles créent un superbe effet de profondeur. Le look rainuré de notre façade Leni mélaminée de qualité supérieure est le summum de l'élégance. Les deux décors permettent des conceptions contemporaines à des conditions intéressantes et des lignes dans la cuisine qui posent de nouveaux jalons en termes de design.

# SUSANN

SANDBEIGE HOCHGLANZ









# BEEINDRUCKENDER BLICKFANG



*IMPRESSIVE LOOKER  
INDRUKWEKKENDE  
BLIKVANGER  
ATTIRE TOUS LES  
REGARDS*

## ELEGANZ AUF GANZER LINIE

**Klappenschränke mit Rauchglastüren bilden einen krönenden Abschluss. Der Spritzschutz Connect am Kochfeld greift das Design auf und verfügt über praktische Steckdosen. Genießer freuen sich über den Komfort eines Weinkühlschranks.**

### *ELEGANCE ACROSS THE BOARD*

Flap-door cabinets with smoky glass doors provide the crowning glory. The Connect splashback behind the hob picks up on the whole design and comes with practical power sockets. Connoisseurs simply love the convenience of a wine refrigerator.

### *ELEGANTIE OVER DE HELE LINIE*

Klepkasten met deuren van rookglas vormen een kroon op het werk. De Connect-spatwand bij de kookplaat sluit aan op het design en heeft praktische stopcontacten. Kenners genieten van het gemak van een wijnkoelkast.

### *ÉLÉGANCE DE A À Z*

Les meubles à abattants, équipés de portes en verre fumé, subliment l'aménagement. Munie de prises femelles pratiques, la plaque antiprojection Connect derrière la table de cuisson reprend le design de la cave à vin qui fera le bonheur des gourmets.

# IDEEN, DIE FREUDE MACHEN

KOMFORT VOLLER IDEEN  
Ob mattschwarze Nischenausstattung  
oder durchdachte Innenorganisation nach  
Maß - LED-Leuchten rücken die über-  
zeugenden Highlights ins rechte Licht.





*INGENIOUS CONVENIENCE* - Whether matt black splashback or bespoke drawer interiors - LED provides the perfect lighting for stunning kitchen elements.

*COMFORT VOL IDEEËN* - Of het nu gaat om een matzwarte nisinrichting of een doordachte interieurorganisatie op maat - led-lampen zetten de overtuigende highlights in het juiste licht.

*CONFORT PLEIN D'IDÉES* - Qu'il s'agisse d'un équipement de crédence noir mat ou d'une organisation intérieure sophistiquée sur mesure, les lampes DEL mettent en lumière les idées novatrices.

*IDEAS THAT EXCITE  
IDEEËN WAAR JE  
PLEZIER AAN BELEEFT  
DES IDÉES QUI  
FONT SOURIRE*





CORA

SHELL OAK

CINDY

SALBEI SEIDENMATT





**In der Küche von heute wird nicht nur gekocht, sie ist zentraler Treffpunkt für schöne Momente. Und ein Ort zum Verweilen, der dank integrierter Thekenlösung zusätzliche Ablagen sowie Sitzmöglichkeiten zugleich bietet.**

Today's kitchen is not just somewhere to cook, it's a meeting hub for lovely moments. And, with integrated counter solution, a place to relax while also providing added surface space as well as somewhere to sit.

In de keuken van vandaag wordt niet alleen gekookt, het is ook een centrale ontmoetingsplaats voor gezellige momenten. En een plek om te vertoeven, die dankzij de geïntegreerde baroplossing extra opberg- en zitmogelijkheden biedt.

De nos jours, la cuisine n'est plus seulement destinée à préparer les repas, elle est aussi le lieu de rencontre par excellence pour des moments inoubliables. C'est un endroit où l'on aime s'attarder, assis confortablement au comptoir intégré qui prolonge également le plan de travail.

EINFACH  
GEMÜTLICH



SCAN ME!

*SIMPLY INVITING  
GEWOON GEZELLIG  
TOUT SIMPLEMENT  
CONFORTABLE*



*RADIANCE NO FINER  
STRALEND MOOI  
RAYONNANTE DE BEAUTÉ*



**STRALEND..  
SCHÖN**

Ob Kalt- oder Warmweiß – leuchtende Akzente in der Küche lassen sich komfortabel und stufenlos per Fernbedienung ansteuern. Auf Wunsch übrigens auch synchron und perfekt aufeinander abgestimmt für ein einheitliches Gesamtbild.

Whether cool or warm white – accent lighting in the kitchen is easily adjusted to any intensity by remote control. Incidentally, it can also be synchronised and perfectly coordinated for a consistent overall impression.

Koud of warm wit – verlichte accenten in de keuken kunnen handig en traploos worden bediend met een afstandsbediening. Op verzoek kunnen ze ook worden gesynchroniseerd en perfect op elkaar worden afgestemd voor een uniform totaalbeeld.

Lumière blanc froid ou blanc chaud, la télécommande permet de régler en continu la température de couleur. Si souhaité, il est possible de synchroniser et d'assortir l'éclairage pour que l'harmonie règne dans la cuisine.





CORA  
EICHE SAND

SUSANN  
POLARWEISS  
HOCHGLANZ





20  
24



# BESTENS

## IM BLICK

EVERYTHING IN VIEW  
ALLES IN HET ZICHT  
TOUT SOUS LES YEUX



Immer alles im Blick in unseren serienmäßigen Vollauszügen: Individuell wählbare Innenausstattungen in pflegeleichten Materialausführungen garantieren, dass alles schnell zur Hand ist und stets Ordnung herrscht. Nachhaltig schön sind Lösungen aus echtem Holz.

Our standard full extension drawers reveal everything: selectable interior fittings in easy care materials not only make sure everything is quickly to hand but always in neat order. Solutions in real wood are lovely and perfectly sustainable.

Altijd alles in het zicht in onze standaard volledig uittrekbare laden: individueel te kiezen interieuruitrustingen in onderhoudsvriendelijke materiaaluitvoeringen garanderen dat alles snel bij de hand is en altijd netjes blijft. Oplossingen van echt hout zijn duurzaam mooi.

Avoir une vue globale sur tout ce qui est dans nos coulissants à sortie totale en série : les équipements intérieurs au choix, faciles d'entretien, mettent de l'ordre afin d'avoir rapidement tout sous la main. Les solutions en bois véritable sont élégantes et durables.



SCAN ME!

**PRAKTISCH** –  
**das Kochfeld mit integriertem Dunstabzug.**  
**Die Kaffeemaschine kommt Genießern auf**  
**einem ausziehbaren Tablar entgegen. Aus**  
**dem Schubkasten darunter klappt sich auf**  
**Wunsch eine Brotschneidemaschine aus.**  
**So komfortabel lässt es sich gut leben.**

*PRACTICAL* – the hob with integrated downdraft extractor. The coffee maker comes out to meet the barista on a pull-out surface. For anyone wanting one, a bread slicer rises out of the drawer below. Life is as convenient as this.

*PRAKTISCH* – de kookplaat met geïntegreerde afzuiging. De koffiemachine komt fijnproevers op een uittrekbaar plateau tegemoet. Een broodsnijmachine verschijnt desgewenst uit de lade eronder. Dit is comfortabel leven.

*PRATIQUE* – La table de cuisson avec hotte intégrée. Placée sur une tablette télescopique, la machine à café vient à la rencontre des gourmets. Sur demande, une trancheuse à pain pliable se cache dans le tiroir en dessous. Pour le confort au quotidien.



## PIFFIG GESTALTET

Ob mit Baguettetasche oder Flaschenhalter, Gewürzaufbewahrung am Herd oder Reinigungsmittelkorb im Spülenschrank – wir haben viele Ideen, die Ihr Küchenleben leichter machen.

*CLEVERLY DESIGNED* – Whether fabric bread bag or bottle holder, storing spices at the cooker or detergent basket in the sink cabinet – we have all sorts of ideas to make kitchen life so much easier for you.

*SLIM ONTWORPEN* – Met een stokbroodzak of flessenhouder, kruidenopslag op het fornuis of afwasmiddelenmandje in de spoelkast – wij hebben veel ideeën om uw keukenleven gemakkelijker te maken.

*SOLUTION JUDICIEUSE* – Sac à pain ou porte-bouteilles, rangement des épices à côté de la table de cuisson ou corbeille pour les produits d'entretien dans le sous-évier : voici quelques-unes de nos idées pour faciliter votre vie dans la cuisine.



SCAN ME!



Eine Designinnovation sind die neuen Durchgangstüren: Sie erlauben diskrete Durchgänge zu Vorrats- und Hauswirtschaftsräumen, die das harmonische Gesamtbild nicht stören. Ein rückschonendes Detail sind Schwerlasttablare für Getränkekränze.

The new through-passage doorways are a design innovation: providing unobtrusive access to storage and utility room spaces that don't spoil the lovely, well-balanced overall picture. As a practical detail, heavy-duty pull-out shelves for bottle crates go easy on back strain.

De nieuwe doorgangsdeuren zijn een designinnovatie: ze maken discrete doorgangen naar voorraadruimtes en bijkeukens mogelijk die het harmonieuze totaalbeeld niet verstoren. Zwaar belastbare plateaus voor drankkratten zijn een rugvriendelijk detail.

Les portes de passage sont une innovation en termes de design : elles dissimulent discrètement le cellier ou l'arrière-cuisine sans perturber l'harmonie visuelle. Les tablettes pour caisse de boissons permettent d'adopter une bonne posture pour éviter les maux de dos.

# AMELIE

KITO STAHL









# DETAILS, DIE BEGEISTERN

## AUF DIE FEINE ART

Wie aus einem Guss wirken Arbeitsflächen und Rückwand. Nahtlos eingefügt unterstreichen die flächenbündigen Funktionszonen fürs Spülen und Kochen die großzügige Ausstrahlung.

### *NICE SOLUTION*

Worktops and splashback come from one and the same mould. Seamlessly integrated, the flush-fitting function zones for sinks and cooking underscore the spacious look.



*DETAILS THAT EXCITE  
DETAILS DIE INSPIREREN  
DES DÉTAILS QUI FONT CRAQUER*

*FIJNZINNIG*

De werkbladen en de achterwand zien eruit alsof ze uit één mal zijn gegoten. De naadloos geïntegreerde functionele zones voor spoelen en koken benadrukken de royale uitstraling.

*L'ART DE LA CUISINE*

Le plan de travail et la crédence semblent avoir été fabriqués d'un seul tenant. Les zones fonctionnelles, intégrées à fleur, pour l'évier et la table de cuisson subliment cet aménagement généreux.



# ERGONOMIE

## AUF ALLEN EBENEN



*ERGONOMICALLY  
PERFECTED  
THROUGHOUT  
ERGONOMIE OP  
ALLE NIVEAUS  
ERGONOMIE  
À TOUS LES  
NIVEAUX*



#### *GEHEEL NAAR WENS*

Een hoog geïntegreerde vaatwasser en transportmodules voor borden zijn nuttige ergonomische hulpmiddelen. Praktisch: rekken aan de binnenkant van scharnierende deuren waarin kruiden klaar staan.

#### *SUR MESURE*

Un lave-vaisselle surélevé et les range-assiettes mobiles sont des accessoires ergonomiques. L'étagère de porte pour les épices est très pratique.

#### GANZ NACH WUNSCH

Ein hoch gebauter Geschirrspüler und Transportmodule für Teller sind sinnvolle ergonomische Helfer. Praktisch: Innenregale an Drehtüren, die Gewürze bereithalten.

#### *EVERYTHING JUST AS YOU WANT IT*

A raised dishwasher and modular plate carriers make for practical and ergonomic helpers. Practical: racks inside hinged doors to hold spices.



# ERGONOMISCH UND NACH MASS

Die exakte Anpassung der Arbeitshöhen ist ein unverzichtbarer Bestandteil jeder Planung. Individuell abgestimmte Schrankmaße entlasten den Rücken und erhöhen den Bedienkomfort enorm. Unser Programm bietet Ihnen eine große Auswahl an Korpshöhen, die perfekt passende Lösungen erlaubt. Die Vielfalt der verschiedenen Schrankhöhen und -tiefen eröffnet Planungsspielraum und ermöglicht eine optimale Ausnutzung des zur Verfügung stehenden Platzes: Höhere und tiefere Schränke garantieren mit jedem zusätzlichen Quadratzentimeter ein Plus an Stauraum. Ihr Fachhändler ermittelt mit Ihnen die für Sie ergonomisch empfehlenswerte Arbeitshöhe. Denn das Maß aller Dinge sind ... Sie.

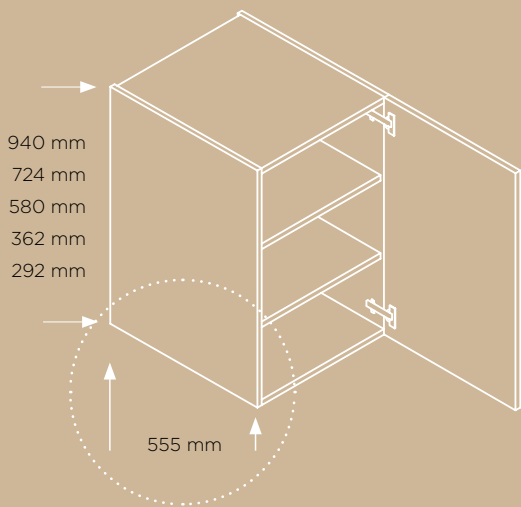

## ERGONOMIC AND BESPOKE

Getting working heights exactly right is an indispensable part of planning any kitchen. Cabinets dimensioned to suit those using them reduce back strain and enhance ease of use. Our line-up gives you a wide choice of carcass heights to provide the perfect solution. The many different cabinet heights and depths open up planning flexibility and optimise the use of available space: taller and deeper units provide extra storage space with every additional square centimetre. Your specialist kitchen retailer will help you find the working height that gives you the greatest ergonomic benefit. Because the measure of all things is ... you.

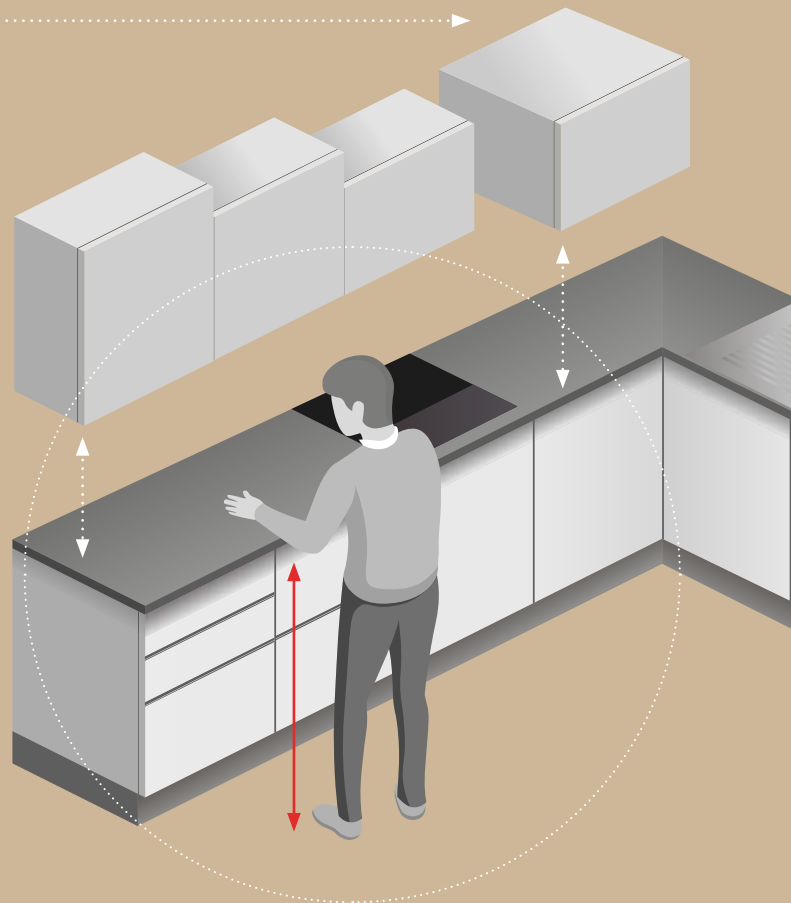

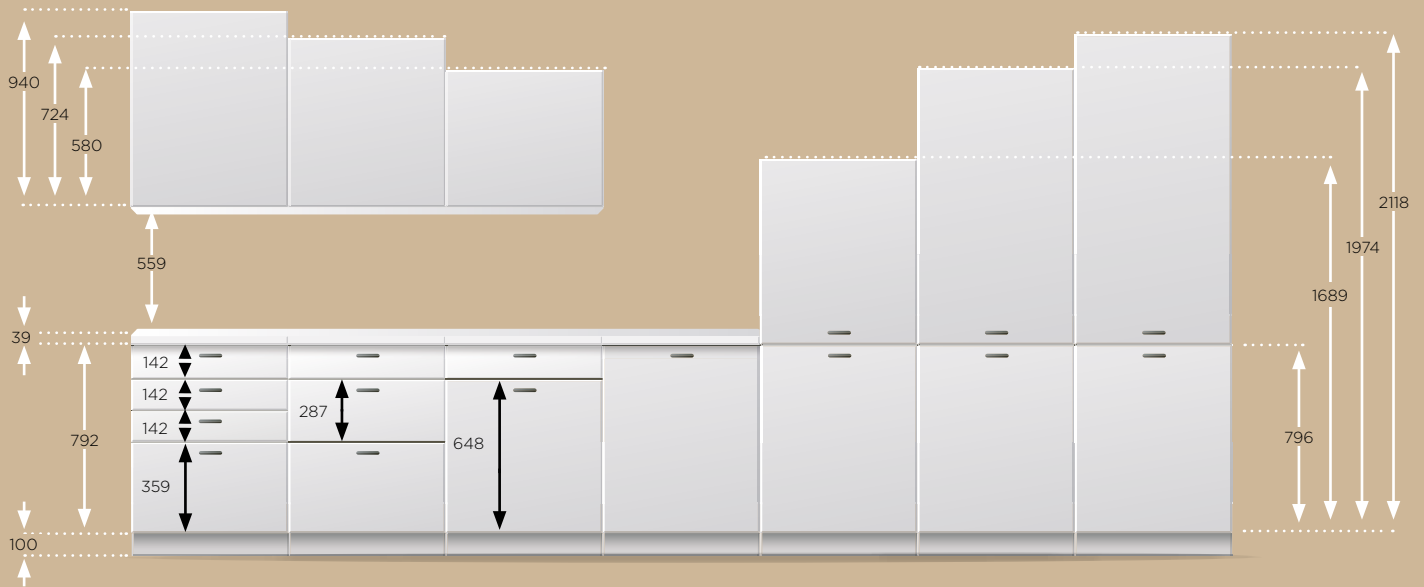

### ERGONOMISCH EN OP MAAT

De exacte afstelling van de werkhogte is een onmisbaar onderdeel van elke planning. Individueel aangepaste kastmaten ontlasten de rug en verhogen het gebruikscomfort enorm. Ons programma biedt u een breed scala aan korpushogtes, waardoor perfect passende oplossingen mogelijk zijn. De verscheidenheid aan kashogtes en -dieptes zorgt voor veel planningsmogelijkheden en maakt een optimaal gebruik van de beschikbare ruimte mogelijk: hogere en diepere kasten garanderen meer opbergruimte met elke extra vierkante centimeter. Uw vakhandelaar bepaalt voor u de ergonomisch aanbevolen werkhogte. Maatgevend voor alle dingen bent ... u.

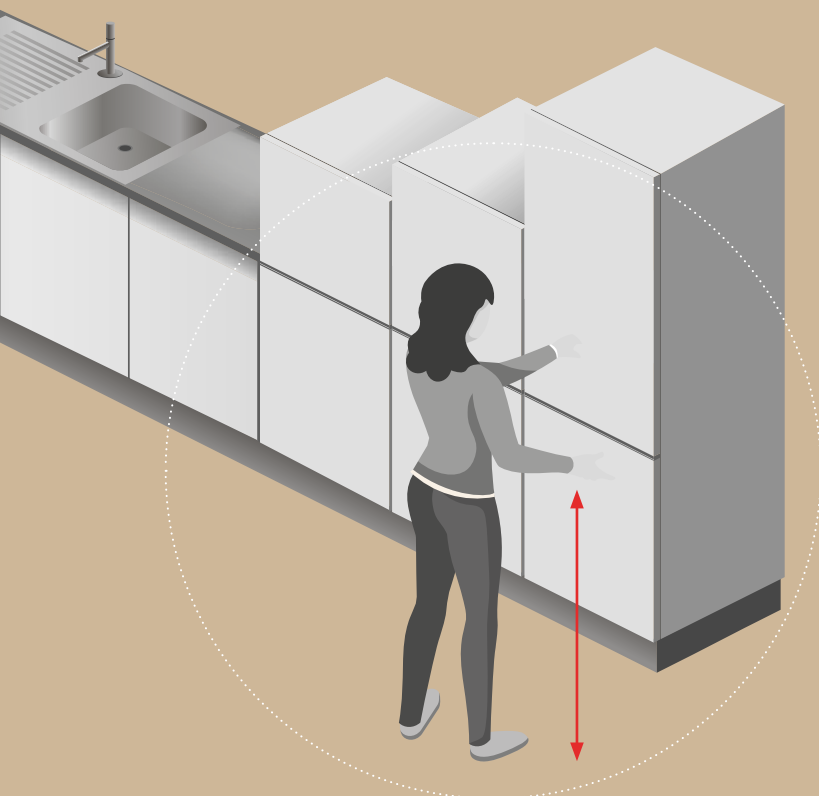

### ERGONOMIE ET SUR MESURE

Il est impératif de personnaliser les hauteurs de travail dans chaque planification. Les meubles sur mesure préservent le dos et assurent un niveau de convivialité encore plus élevé. Nous vous proposons un grand choix de hauteurs de corps qui permettent de trouver la meilleure solution. Les nombreuses hauteurs et profondeurs de meubles offrent une grande liberté d'aménagement et optimisent l'espace disponible pour profiter d'un rangement accru en exploitant chaque centimètre carré de la cuisine. Votre revendeur vous aide à trouver votre hauteur de travail ergonomique. Car vous êtes ce qu'il y a de mieux.

# ERGONOMIE IM SCHNITTPUNKT

Die Hauptbereiche jeder Küche sind 1. das Kühlen und die Vorratshaltung, 2. das Kochen und 3. das Spülen. Sie bilden die Eckpunkte des Arbeitswege-Dreiecks. Die Wege zwischen ihnen sollten maximal 1,50 Meter lang sein. Das garantiert kurze Wege und Bewegungsspielraum. Die Vorbereitungszone findet ihren Platz zwischen Spüle und Herd und verfügt über mindestens 60 Zentimeter Breite. Vorräte werden nahe des Vorbereitungsplatzes aufbewahrt.

Kochgeschirr und Gewürze sollten am Kochfeld griffbereit sein. Das Arbeitswege-Dreieck lässt sich in nahezu allen Küchenformen und -größen realisieren. Die Anordnung der Schränke erfolgt entsprechend den Arbeitsschritten – für Rechtshänder im Uhrzeigersinn, für Linkshänder in entgegengesetzter Richtung. Mit einer ergonomisch durchdachten Ausstattung lässt sich Ihre Küche so wie eine perfekt eingerichtete Werkstatt auf Ihre Wünsche abstimmen.

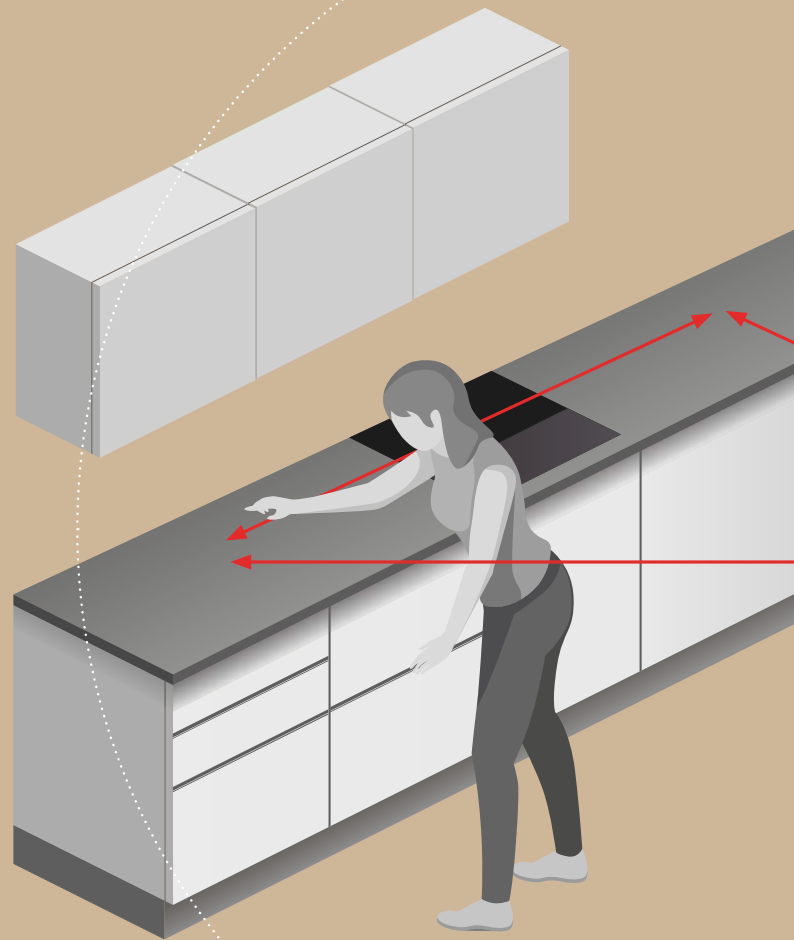

## *ERGONOMICS AT THE CROSSROADS*

The three main zones in any kitchen are 1. refrigeration and food storage, 2. cooking and 3. washing-up. They form the corners of a work triangle. They should be no further than 1.50 metres apart. This guarantees short distances and sufficient room to manoeuvre. The preparation zone is located between the sink and the cooker and is at least 60 centimetres wide. Provisions are kept close to the preparation zone. Cookware and spices should be in easy reach at the hob.

The work triangle can be produced in kitchens of almost any shape and size. Work steps govern the way in which the units are arranged – clockwise for right-handed people and in the opposite direction for the left-handed. Ergonomically designed throughout, your new kitchen can be tailored exactly to your wishes in just the same way as a perfectly equipped workshop.



### ERGONOMIE IN DE FOCUS

De drie belangrijkste onderdelen van elke keuken zijn 1. koelen en voorraadopslag, 2. koken en 3. afwassen/spoelen. Zij vormen de hoekpunten van de werkwegdriehoek. De paden ertussen mogen maximaal 1,50 meter lang zijn. Dit garandeert korte afstanden en bewegings-/speelruimte. De voorbereidingszone bevindt zich tussen de spoelbak en het fornuis en is minimaal 60 centimeter breed. Voorraden worden bewaard in de buurt van de voorbereidingszone. Kookgerei en kruiden moeten binnen handbereik zijn bij de kookplaat.

De werkwegdriehoek kan in bijna alle keukenvormen en -afmetingen worden gerealiseerd. De kasten zijn gerangschikt volgens de werkstappen - met de klok mee voor rechtshandigen en in omgekeerde richting voor linkshandigen. Met een ergonomisch doordachte uitrusting kan uw keuken worden afgestemd op uw wensen, net als een perfect uitgeruste werkplaats.

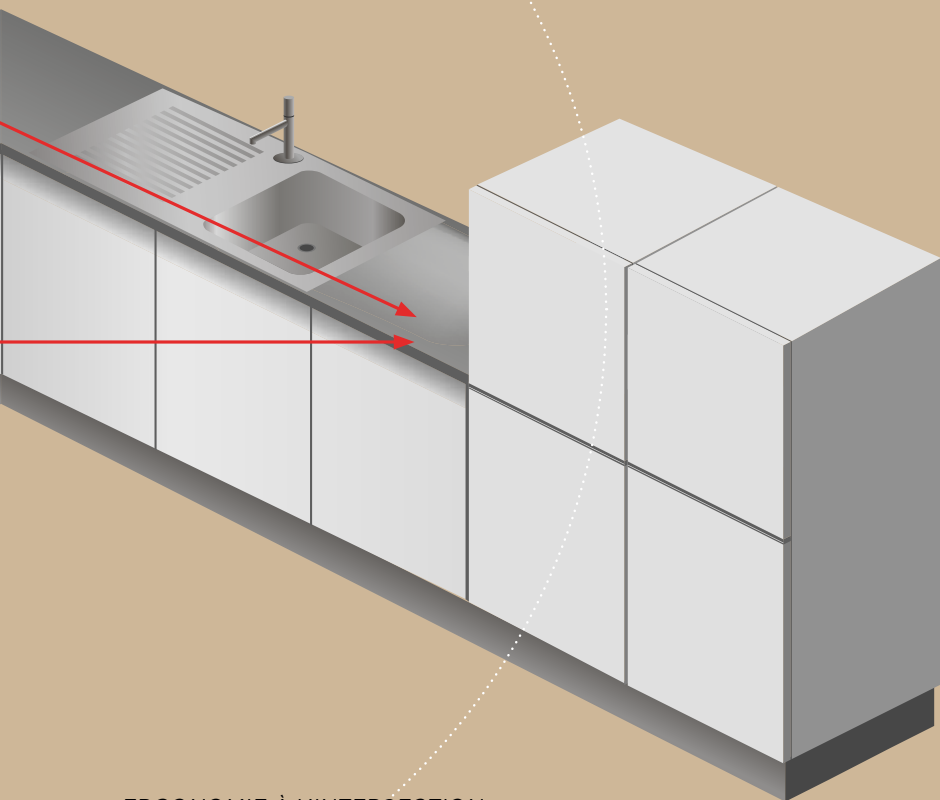

### ERGONOMIE À L'INTERSECTION

Chaque cuisine s'organise autour de trois zones : le froid / les provisions, la cuisson et le lavage. Dans le meilleur des cas, elles constituent les sommets du triangle d'activités. Elles ne devraient pas être espacées de plus de 1,50 m, ce qui évite les déplacements inutiles tout en facilitant la circulation. La zone de préparation, au moins 60 cm de large, se situe entre l'évier et la table de cuisson, les provisions sont rangées à côté. Il est conseillé de garder à disposition les casseroles et les épices.

Il est possible de réaliser un triangle d'activités dans presque chaque cuisine, quelle que soit sa forme ou sa taille. Les meubles sont disposés en fonction des tâches à effectuer : dans le sens horaire pour les droitiers, dans le sens antihoraire pour les gauchers. Aménagée en tenant compte de l'ergonomie, votre nouvelle cuisine comblera tous vos souhaits, comme un atelier parfaitement équipé.

# ERGONOMISCHE ARBEITSHÖHE

ERGONOMIC WORKING HEIGHT  
ERGONOMISCHE WERKHOOGTE  
HAUTEUR DE TRAVAIL ERGONOMIQUE

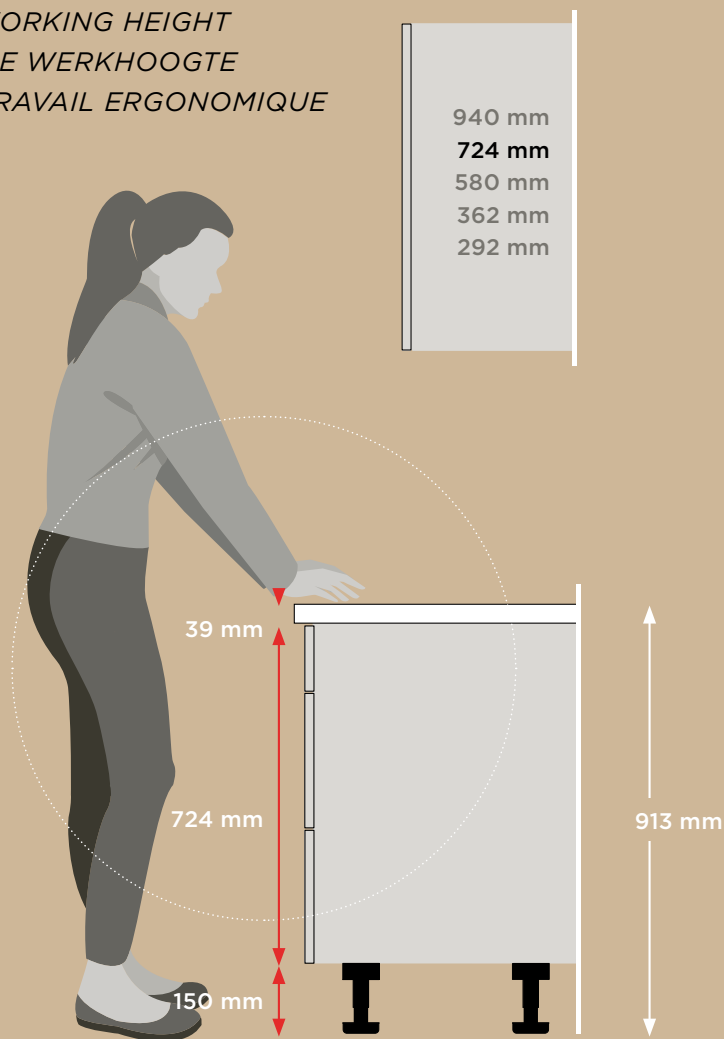

## ARBEITSPLETTEN

WORKTOPS WERKBLADEN  
PLANS DE TRAVAIL

16 MM | 25 MM | 39 MM

## SOCKELHÖHEN

PLINTH HEIGHTS PLINTHOOGTES  
HAUTEURS DE SOCLE

75 MM | 100 MM | 125 MM  
150 MM | 175 MM | 200 MM

## KORPUSTIEFEN

CARCASE DEPTHS KORPUSDIEPTES  
PROFONDEURS DE CORPS

335 MM | 455 MM | 555 MM | 705 MM

### MIT MASS ZUM KOMFORT

Die Bauhöhe ist nicht alles: Eine Arbeitshöhe ergibt sich immer aus dem Zusammenspiel von Korpus, Arbeitsplatte und Sockel. Ziel ist es, die perfekte Abstimmung für Sie zu finden, um maximalen Komfort in Ihrer Küche zu erreichen. Höhenverstellbare Sockel und Arbeitsplatten in verschiedenen Stärken erlauben zusätzlichen Spielraum für Anpassungen.

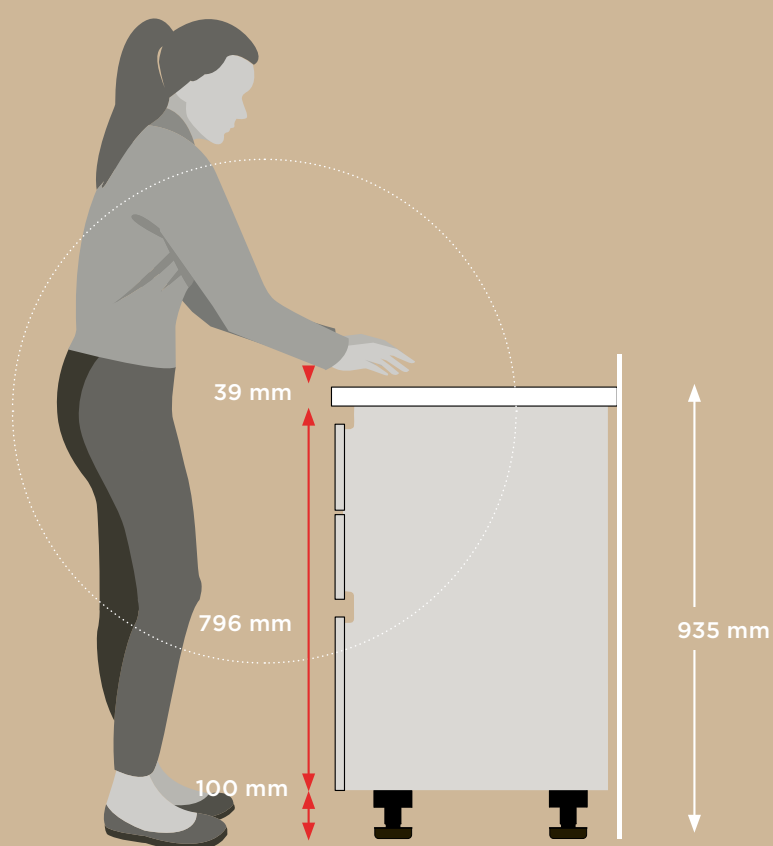

### CONVENIENCE THAT MEASURES UP

Overall height isn't everything: working height is always the sum of carcass, worktop and plinth. The aim is to find the perfect balance for you so as to maximise convenience in your kitchen. Height-adjustable plinths and worktops in various thicknesses provide additional scope for getting everything just right.

### MAATCOMFORT

De totale hoogte is niet alles: een werkhoogte is altijd het resultaat van de interactie tussen korpus, werkblad en plint. Het doel is om voor u de perfecte match te vinden voor maximaal comfort in uw keuken. In hoogte verstelbare plinten en werkbladen in verschillende diktes bieden extra speelruimte voor aanpassingen.

### CONFORT SUR MESURE

La hauteur de planification n'est pas tout : la hauteur de travail dépend toujours des corps, plan de travail et socle. L'objectif est de trouver la vôtre afin que vous ayez le maximum de confort dans votre cuisine. En outre, les socles réglables en hauteur et les plans de travail en plusieurs épaisseurs assurent un ajustement encore plus précis.

# GENUSS BRAUCHT ORDNUNG



Ob Messerblock, Platz für Gewürze oder für 1000 andere Dinge, die das Kochen schöner machen: Unsere Innenausstattungen passen sich Ihren Wünschen an. Es gibt sie in verschiedenen Größen und auf Wunsch mit modularer Einteilung nach Maß. Aus Echtholz oder hochwertigem Kunststoff.



### *LOVERS OF ORGANISATION*

Whether knife block, spices rack or all sorts of other things that make cooking such a pleasure: our interior fittings give you everything you want. They come in different sizes and, on request, with bespoke modular partitioning. In real wood or high-quality plastic.

### *ALLES NETJES IS EEN GENOT*

Of het nu gaat om het messenblok, ruimte voor kruiden of voor de 1000 andere dingen die het koken aangenamer maken: onze interieuruitrusting past zich aan uw wensen aan. Ze zijn verkrijgbaar in verschillende afmetingen en, op verzoek, met modulaire indeling op maat. Van echt hout of hoogwaardige kunststof.

### *ALLIER PLAISIR ET ORDRE*

Qu'il s'agisse de bloc couteaux, de place pour les épices ou pour les milliers d'autres choses qui embellissent la cuisine : nos équipements intérieurs répondent à vos souhaits. Ils sont disponibles en plusieurs tailles et, sur demande, modulables. En bois véritable ou en plastique haut de gamme.



# AMELIE

SAND



NATURAL AMBIENCE  
NATUURLIJKE AMBIANCE  
AMBIANCE NATURELLE

# NATÜRLICHES AMBIENTE



# ALLES AN SEINEM PLATZ



Wir denken Stauraum neu - zum Beispiel mit unseren herausnehmbaren Tellerhaltern in geräumigen Auszügen oder schmalen Reinigungsmittelkörben im Spülenunterschrank.

We are rethinking storage space - with features like our removable plate holders in spacious pull-outs or narrow detergent baskets in the sink cabinet.

We hebben opberg ruimte opnieuw uitgedacht - bijvoorbeeld met onze uitneembare bordenhouders in ruime uittrekelementen of smalle manden voor reinigingsmiddelen in de spoelonderkast.

Nous réinventons l'espace de rangement - par exemple, avec nos portes-assiettes amovibles dans les coulissants géants ou avec les paniers étroits pour les produits d'entretien dans le sous-évier.





**GELUNGENER ABSCHLUSS** – Unsere neuen Deckenblenden perfektionieren besonders großzügige, deckenhohe Planungen und öffnen weitere Stauraumoptionen.

*TOPPING IT ALL* – Opening up further storage options, our new top front panels make particularly spacious, ceiling-height units just perfect.

*GESLAAGDE AFRONDING* – onze nieuwe plafondpanelen zijn perfect voor bijzonder ruime, plafondhoge indelingen en bieden nog meer opbergmogelijkheden.

*FINITION RÉUSSIE* – Nos bandeaux de finition subliment les planifications généreuses jusqu'au plafond et optimisent le rangement.

**EVERYTHING IN ITS PLACE**  
**ALLES OP ZIJN PLEKJE**  
**TOUT EST PARFAITEMENT**  
**BIEN RANGÉ**





JETTE

GREIGE SEIDENMATT

AMELIE

MOCCA



# IN SCHÖNSTER HARMONIE

*IN LOVELY HARMONY  
IN ESTHETISCHE HARMONIE  
TOUT EN HARMONIE*

## MARA

SALBEI SEIDENMATT  
GREIGE SEIDENMATT









SOPHIE  
GREIGE SEIDENMATT





**Ton in Ton: Die seidenmatt lackierte Rahmenfront begeistert mit sorgfältiger handwerklicher Verarbeitung im sanften Farbton Greige. Landhausgriffe, Vitrinenschränke und Sichtseiten mit Paneelwirkung unterstreichen den sympathischen Cottage Style.**

*WITH HUGE AURA*

Tone in tone: the silky matt lacquered framed front captivates with meticulous craftsmanship in the subtle shade of greige. Country-style handles, glass display cabinets and visible sides with panel effect underscore the appealing Cottage Style.

*MET VEEL SFEER*

Ton sur ton: het zijdemat gelakte raamwerkfront valt in de smaak met een zorgvuldige handmatige afwerking in de zachte kleur greige. Landhuisgrepen, vitrinekasten en zichtbare zijden met paneleffect onderstrepen de sympathieke cottage style.

*AMBIANCE EXCLUSIVE*

Ton sur ton : la façade à cadre laqué mat soyeux séduit par une finition artisanale méticuleuse en teinte grège discrète. Les poignées champêtres, les vitrines et les côtés visibles, façon panneaux, soulignent l'élégance du style Cottage.



MIT VIEL  
ATMOSPHÄRE





**ELEGANTE  
AUSSTRAHLUNG**  
Ein Buffett in Vitrinen-Optik  
wird zum einzigartigen Blick-  
fang. Der sanfte Farbton  
Greige bringt das Ensemble  
im Zusammenspiel mit Glas  
und Licht zum Strahlen. Die  
LED-Einbauleuchten **Glaspoint**  
sorgen für echte Wow-Effekte.

*ELEGANT AURA*

A sideboard in glass display cabinet look makes a unique eye-catcher. The soft greige shade makes brings radiance to this ensemble in combination with glass and light. **Glaspoint** LED lights say "wow".

*ELEGANTE UITSTRALING*

De buffetkast in vitrine-look wordt een unieke blikvanger. De zachte tint Greige laat het geheel schitteren in het samenspel van glas en licht. De **Glaspoint** led-inbouwlampen zorgen voor echte wow-effecten.

*RAYONNE D'ÉLÉGANCE*

Un buffet, conçu comme une vitrine, attire tous les regards. La teinte grège discrète, associée au verre et à la lumière, illumine l'ambiance de cet aménagement. Les lampes DEL intégrées **Glaspoint** créent un véritable effet de surprise.



**SCAN ME!**



SOPHIE

NEBELGRAU SEIDENMATT

JETTE

SCHWARZ SEIDENMATT





# SOPHIE

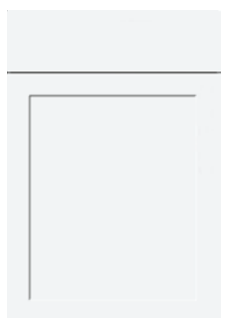

SOPHIE 370

**Weiß seidenmatt**  
White silky matt  
Wit zijdemat  
Blanc mat soyeux

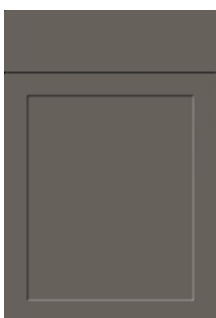

SOPHIE 371

**Quarzgrau seidenmatt**  
Quartz grey silky matt  
Kwartsgrijs zijdemat  
Gris quartz mat soyeux

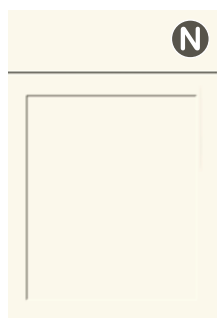

SOPHIE 372

**Silk seidenmatt**  
Silk silky matt  
Silk zijdemat  
Silk mat soyeux

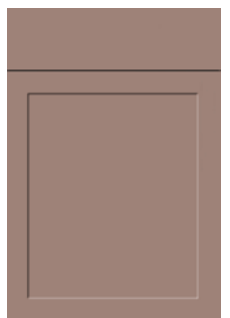

SOPHIE 373

**Greige seidenmatt**  
Greige silky matt  
Greige zijdemat  
Grège mat soyeux

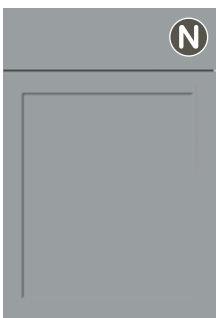

SOPHIE 374

**Nebelgrau seidenmatt**  
Mist grey silky matt  
Mist grijs zijdemat  
Gris brume mat soyeux

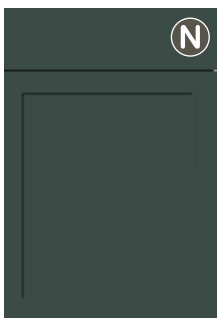

SOPHIE 375

**Black green seidenmatt**  
Black green silky matt  
Black green zijdemat  
Black green mat soyeux

## ALLES IM RAHMEN

Ob mit glatter oder erhabener Füllung - Rahmenfronten beweisen Stil und vermitteln Geborgenheit. SOPHIE wirkt besonders frisch und modern. MARA beweist Liebe zum Detail. Die seidenmatt lackierten Oberflächen beider Modelle garantieren in Optik, Haptik und im edlen Finish ein außergewöhnlich schönes Ambiente. Für beide Serien haben wir das farblich passende Umfeld mit z. B. Wangen, Böden, Sockel und Regalen im Programm. Alles nach Maß und Wunsch.

## SETTING THE FRAME

Whether with smooth or raised infill panel - framed fronts are a statement of style and convey a homely feel. SOPHIE enters the stage with a particularly refreshing and modern look. MARA demonstrates a love of detail. The silky matt lacquered surfaces give both models an exquisite look, feel and finish to guarantee a delightful ambience second to none. Complementing both ranges, our line-up features surrounding elements in matching colour, such as side, top and bottom panels, shelves and plinths. All made to measure and exactly to your liking.



# MARA



## ALLES MOOI INGEKADERD

Met glad of gestructureerd binnenpaneel - raamwerkfronten stralen stijl uit en geven een gevoel van geborgenheid. SOPHIE heeft een bijzonder frisse en moderne uitstraling. MARA toont liefde voor details. De zijdematte lakoppervlakken van beide modellen staan garant voor een buitengewoon mooie ambiance wat betreft uiterlijk, gevoel en stijlvolle afwerking. Voor beide series hebben we de bijpassende kleuromgeving met o.a. stollenwanden, legplanken, plinten en open kasten in ons assortiment. Alles op maat en naar wens.

## TOUT DANS UN CADRE

Avec un panneau central lisse ou en relief, les façades à cadre témoignent de notre savoir-faire en matière de style et créent une ambiance chaleureuse. SOPHIE semble fraîche et moderne. MARA affiche son amour pour les détails. Les surfaces laquées mat soyeux de ces deux modèles apportent une allure chic et élégante en termes de visuel, de toucher et de finition. Pour ces deux séries, nous proposons des éléments assortis, par ex. joues, tablettes, socles et étagères. Tout sur mesure.



MARA 435

**Sandbeige seidenmatt**  
Sand beige silky matt  
Zandbeige zijdemat  
Beige sable mat soyeux



MARA 436

**Moonlight grey seidenmatt**  
Moonlight grey silky matt  
Moonlight grey zijdemat  
Moonlight grey mat soyeux



MARA 437

**Salbei seidenmatt**  
Sage silky matt  
Salie zijdemat  
Sauge mat soyeux



MARA 438

**Silk seidenmatt**  
Silk silky matt  
Silk zijdemat  
Silk mat soyeux



MARA 439

**Weiß seidenmatt**  
White silky matt  
Wit zijdemat  
Blanc mat soyeux



MARA 446

**Quarzgrau seidenmatt**  
Quartz grey silky matt  
Kwartsgrijs zijdemat  
Gris quartz mat soyeux



MARA 448

**Schwarz seidenmatt**  
Black silky matt  
Zwart zijdemat  
Noir mat soyeux



MARA 449

**Greige seidenmatt**  
Greige silky matt  
Greige zijdemat  
Grège mat soyeux

# GEFÜHL FÜR STIL

*SENSE OF STYLE  
GEVOEL VOOR STIJL  
LE SENS DU STYLE*



# MARA

SILK SEIDENMATT







# IN SCHÖNSTER FRISCHE

Weiß, Glas und Lichtakzente vermitteln Leichtigkeit. Der pfiffig konzipierte Eckschrank **Space Corner** beweist sein Stauraumtalent im Alltag. Auf ein neues Wohngefühl!

*Wonderfully refreshing*

White, glass and accent lighting conjure a light and airy feel. The cleverly designed **Space Corner** unit demonstrates its talent as a provider of storage space in everyday use. Here's to a new feeling of home living!

*Heerlijke frisheid*

Wit, glas en lichtaccenten zorgen voor een lichte sfeer. De slim ontworpen hoekkast **Space Corner** bewijst zijn opbergtalent elke dag opnieuw. Verheug u op een nieuw woongevoel!

*Un souffle de fraîcheur*

Blanc, verre et touches lumineuses pour plus de légèreté. Le meuble d'angle **Space Corner** astucieux multiplie les options de rangement. Au nouvel art d'habiter !



SCAN ME!





*FACETS THAT BRING JOY  
SMAAKVOLLE FACETTEN  
C'EST UNE JOIE PURE*



# Facetten

## VOLLER FREUDE







# JETTE

POLARWEISS  
SEIDENMATT







*TIMELESS APPEAL  
TIJDLOZE SCHOONHEID  
BEAUTÉ INTEMPORELLE*

# ZEITLOSE SCHÖNHEIT

**Nuancen erwecken Einrichtungen zum Leben und werden von Lichtquellen gezielt in Szene gesetzt. Besonderer Hingucker: Rauchglas für den modernen Touch.**

Nuances bring furnishings to life and are shown off with stunning effect by sources of light. Particular eye-catcher: smoked glass for a modern touch.

Nuances brengen meubels tot leven en worden specifiek geënsceeneerd door lichtbronnen. Bijzondere blikvanger: rookglas voor een moderne touch.

Les nuances subliment les équipements et les sources lumineuses les mettent subtilement en scène. Attire toujours l'attention : le verre fumé pour une touche moderne.

ANTI-FINGERPRINT

# OBERFLÄCHE

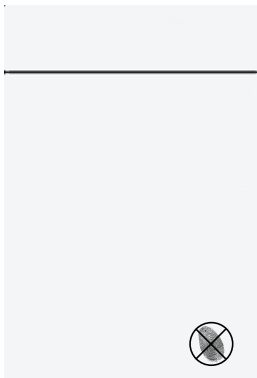

JETTE 275  
**Weiß seidenmatt**  
White silky matt  
Wit zijdemat  
Blanc mat soyeux



JETTE 276  
**Greige seidenmatt**  
Greige silky matt  
Greige zijdemat  
Grège mat soyeux

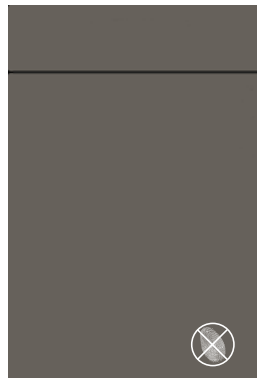

JETTE 277  
**Quarzgrau seidenmatt**  
Quartz grey silky matt  
Kwartsgrijs zijdemat  
Gris quartz mat soyeux

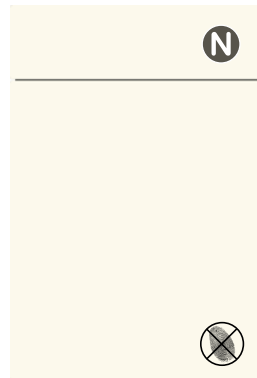

JETTE 278  
**Silk seidenmatt**  
Silk silky matt  
Silk zijdemat  
Silk mat soyeux

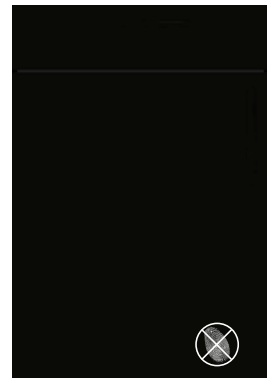

JETTE 279  
**Schwarz seidenmatt**  
Black silky matt  
Zwart zijdemat  
Noir mat soyeux

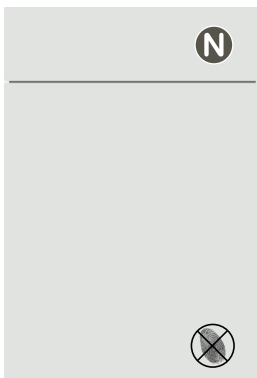

JETTE 280  
**Moonlight grey seidenmatt**  
Moonlight grey silky matt  
Moonlight grey zijdemat  
Moonlight grey mat soyeux

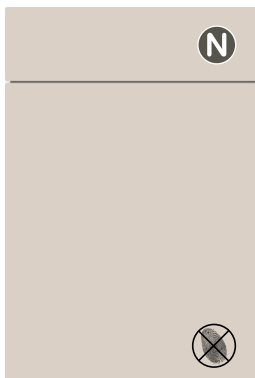

JETTE 281  
**Sandbeige seidenmatt**  
Sand beige silky matt  
Zandbeige zijdemat  
Beige sable mat soyeux

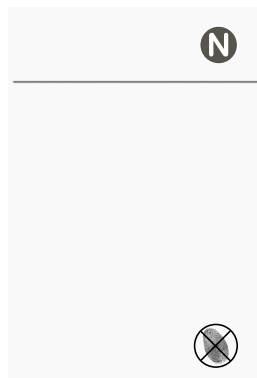

JETTE 282  
**Polarweiß seidenmatt**  
Polar white silky matt  
Polarwit zijdemat  
Blanc polaire mat soyeux

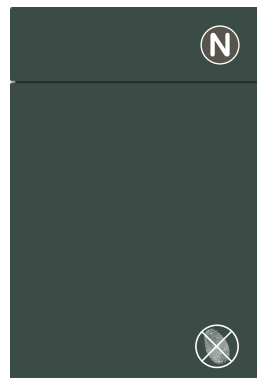

JETTE 286  
**Black green seidenmatt**  
Black green silky matt  
Black green zijdemat  
Black green mat soyeux



JETTE 287  
**Nebelgrau seidenmatt**  
Mist grey silky matt  
Mist grijs zijdemat  
Gris brume mat soyeux

# JETTE



**Keine Chance für Fingerabdrücke: Dank des Anti-Fingerprint-Effektes vereint JETTE eine außergewöhnlich schöne Optik mit Pflegeleichtigkeit. Die robusten Oberflächen nehmen so schnell nichts übel, was an dem verwendeten UV-Lack liegt, der im Gießverfahren aufgetragen wird. Beim Aushärten setzen wir eine konzentrierte UV-Strahlung in Verbindung mit Nanopartikeln ein, was für einen einzigartigen Look, Feel & Touch sorgt.**

## *ANTI-FINGERPRINT SURFACE FINISH*

This is where finger marks don't stand a chance: benefiting from the anti-fingerprint effect, JETTE combines exceptional beauty with easy maintenance. The hard-wearing surfaces take everything in their stride, which is all down to the UV lacquer coating that's applied in a type of casting process. At the curing stage, we use concentrated UV radiation in combination with nano particles to provide a unique look, feel and touch.

## *ANTI-FINGERPRINT-OPPERVLAK*

Geen kans voor vingerafdrukken: dankzij het Anti-fingerprint-effect combineert JETTE een uitzonderlijk mooie look met onderhoudsgemak. De robuuste oppervlakken zijn zeer vergevingsgezind, wat te danken is aan de gebruikte UV-lak, die in een gietprocedé wordt aangebracht. Bij het uitharden gebruiken we geconcentreerde UV-straling in combinatie met nanodeeltjes, wat zorgt voor een unieke look, feel & touch.

## *SURFACE ANTI-TRACES DE DOIGTS*

Finies les traces de doigts : grâce à un revêtement spécial, JETTE allie élégance exceptionnelle et entretien facile. Les surfaces robustes supportent les traitements les plus rudes, ce qui est dû à la laque UV utilisée, appliquée en machine à rideau. Pour le durcissement, nous misons sur un rayonnement UV concentré, associé à des nanoparticules, ce qui permet d'obtenir une surface au design, à la finesse et au toucher exceptionnels.







CINDY

GREIGE



CINDY  
WEISS SEIDENMATT





#### *NEAT SOLUTIONS*

Household helpers at an ergonomic height, like this heavy-duty unit, are always a good idea. There's even storage space left over in room corners or under the sink. Good planning makes efficient use of every last inch in the utility room.

#### *FRAAIE OPLOSSINGEN*

Huishoudhulpjes op ergonomische hoogte, zoals in deze zwaar belastbare kast, zijn altijd een goed idee. Er is zelfs opbergruimte in de hoeken van de kamer of onder de gootsteen. Met een goede planning kan elke vierkante centimeter in de bijkeuken efficiënt worden gebruikt.

#### *SOLUTIONS PROPRES*

L'électroménager à hauteur ergonomique, comme dans ce meuble très résistant, est toujours une bonne idée. Des espaces de rangement ont même été prévus dans le meuble d'angle ou sous l'évier. Une bonne planification permet ainsi d'exploiter efficacement chaque centimètre carré dans l'arrière-cuisine.





Haushaltshelfer auf ergonomischer Höhe wie in diesem hochbelastbaren Schranktyp sind immer eine gute Idee. Stauraum-Reserven stecken selbst in Zimmerecken oder unter der Spüle. Mit guter Planung lässt sich im Hauswirtschaftsraum so jeder Quadratzentimeter effizient nutzen.

# SAUBERE LÖSUNGEN



# CLEVER EINGERICHTET

*CLEVERLY FURNISHED  
SLIM INGERICHT  
AMÉNAGEMENT JUDICIEUX*

## MAXIMAL FUNKTIONAL:

**Zur Ausstattung von Hauswirtschaftsräumen haben wir neben Hochschranktypen mit extra viel Stauraum zahlreiche raffiniert geplante Ausstattungshighlights im Programm. Mit ihnen lässt sich der zur Verfügung stehende Platz optimal ausnutzen und höchst individuell planen.**

### *MAXIMUM PRACTICALITY:*

In addition to tall unit types with an extra lot of storage space, our product range also features cleverly planned highlights for configuring utility rooms. They make optimum use of available space and provide maximum planning flexibility to suit any situation.

### *MAXIMAAL FUNCTIONEEL:*

Voor de inrichting van bijkeukens bieden wij behalve hoge kasten met extra veel opbergruimte talrijke, geraffineerd geplande inrichtingsdetails. Hiermee kan de beschikbare ruimte optimaal benut en zeer individueel gepland worden.

### *LE MAXIMUM DE FONCTIONNALITÉ :*

Pour aménager l'arrière-cuisine, nous proposons outre les armoires très spacieuses de nombreuses options et accessoires judicieux dans notre programme. Ils permettent d'utiliser pleinement la place disponible et de l'aménager sur mesure.





# LEUCHTENDES

## BEISPIEL



SHINING EXAMPLE  
LICHTEND VOORBEELD  
EXEMPLE LUMINEUX



CORA

COFFEE OAK

CINDY

MARSHMALLOW  
SEIDENMATT



CINDY

MARSHMALLOW SEIDENMATT



CINDY

GREIGE



CINDY

BLACK GREEN  
SEIDENMATT

LENI

SOFT GROOVE









LARA

QUARZGRAU SEIDENMATT



#### OUR FAVOURITE PLACE

Our multi-talented **Easy** splashback railing system gets everything looking neat and tidy in seconds flat. Clever and practical: the **Denver** LED shelf light is a storage surface and glare-free light source all in one.

#### ONS LIEVELINGSPLEKJE

Ons nisrelingsysteem **Easy** is een multitalent dat in een mum van tijd orde schept. Geraffineerd en praktisch: led-plankverlichting **Denver** is een niet-verblindende lichtbron, maar biedt ook opbergruimte.

#### NOTRE PLACE PRÉFÉRÉE

Toujours parfaitement organisée, notre main courante de crédence **Easy** met de l'ordre en un tournemain. Le luminaire DEL pour tablette éclairée **Denver**, pratique et judicieux, sert de surface de rangement et source d'éclairage tamisé.



# UNSER LIEBLINGSPLATZ

Als Multitalent präsentiert sich unser Nischenrelingsystem **Easy**, das im Handumdrehen Ordnung schafft. Raffiniert und praktisch: Die LED-Regalbodenleuchte **Denver** ist Ablagefläche und blendfreie Lichtquelle in einem.





# ERHELLENDE AUSSICHTEN

Mit Lichtakzenten lässt sich Schönes in Szene setzen:  
Die Anbauleuchte **Glaspoint** haben wir für herkömmliche  
Regalböden und als zweiseitig strahlende Variante im  
Programm. Sie verleiht Möbeln mit Glas eine faszinierende  
Raumwirkung. Als dimmbare, stufenlos in der  
Farbtemperatur regelbare LED-Ausführung -  
optional auch per Smart Living steuerbar.

## *BRIGHT PROSPECTS*

Accent lighting sets the stage for lovely pieces:  
we can give you the **Glaspoint** surface-mounted light for conventional  
shelves as well as in the form of an option that illuminates from both  
sides. It gives a fascinating feeling of space to furniture with elements  
of glass. As a dimmable LED version with infinitely variable colour  
temperature - by way of option, also controllable via Smart Living.



## *VERLICHTE UITZICHTEN*

Mooie spullen kunnen met lichtaccenten fraai in scène worden gezet: de **Glaspoint** opbouwarmatuur is bij ons verkrijgbaar voor conventionele legplanken en als tweezijdig stralende variant. Hij geeft meubels met glas een fascinerend ruimtelijk effect. Als dimbare, qua kleurtemperatuur traploos regelbare led-uitvoering - optioneel ook regelbaar via Smart Living.

## *PERSPECTIVES LUMINEUSES*

Utiliser la lumière pour mettre en valeur les objets décoratifs : nous proposons l'applique **Glaspoint** pour les tablettes d'étagère traditionnelles et comme modèle éclairant de deux côtés. Elle confère aux meubles en verre une incroyable sensation d'espace. Disponible en finition DEL, avec intensité variable et température de couleur réglable en continu, commande via Smart Living en option.

# LARA

IN GROSSER KLARHEIT  
Geradlinig in der Formensprache  
begeistern die Designküchen  
LARA und LAILA mit ihrer puren  
Ästhetik. Ob mit Griffen oder ohne,  
mit passenden Sichtseiten oder  
mit Akzentfarben realisiert - der  
hochwertige Frontlack spiegelt  
Klasse und Anspruch wider. Sie  
haben die Wahl zwischen LARA  
in einer eleganten seidenmatten  
Lackierung und LAILA, die  
mit einer repräsentativen  
hochglanzlackierten Front die  
Blicke auf sich zieht.



## CLEAR STATEMENT

Sleek and stylish, our LARA and LAILA designer kitchens simply excite with unadulterated aesthetic appeal. Whether with or without handles, with matching visible sides or with accent colours - the high-quality front lacquer reflects class and discerning taste. You have the choice between LARA in an elegant, silky matt lacquer finish and LAILA, which attracts attention with a prestigious-looking front in high-gloss lacquer.

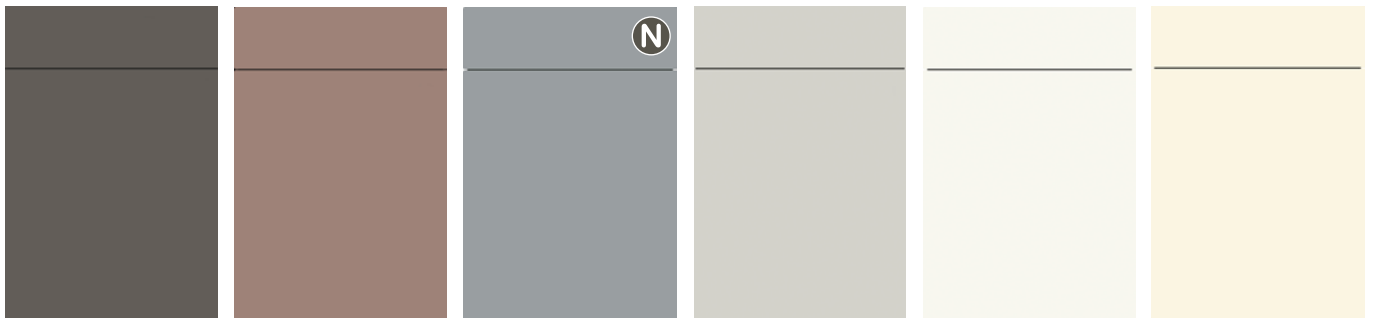

LARA 356

**Quarzgrau seidenmatt**  
Quartz grey silky matt  
Kwartzgrijs zijdemat  
Gris quartz mat soyeux

LARA 357

**Greige seidenmatt**  
Greige silky matt  
Greige zijdemat  
Grège mat soyeux

LARA 358

**Nebelgrau seidenmatt**  
Mist grey silky matt  
Mist grijs zijdemat  
Gris brume mat soyeux

LARA 389

**Moonlight grey seidenmatt**  
Moonlight grey silky matt  
Moonlight grey zijdemat  
Moonlight grey mat soyeux

LARA 391

**Weiß seidenmatt**  
White silky matt  
Wit zijdemat  
Blanc mat soyeux

LARA 392

**Silk seidenmatt**  
Silk silky matt  
Silk zijdemat  
Silk mat soyeux



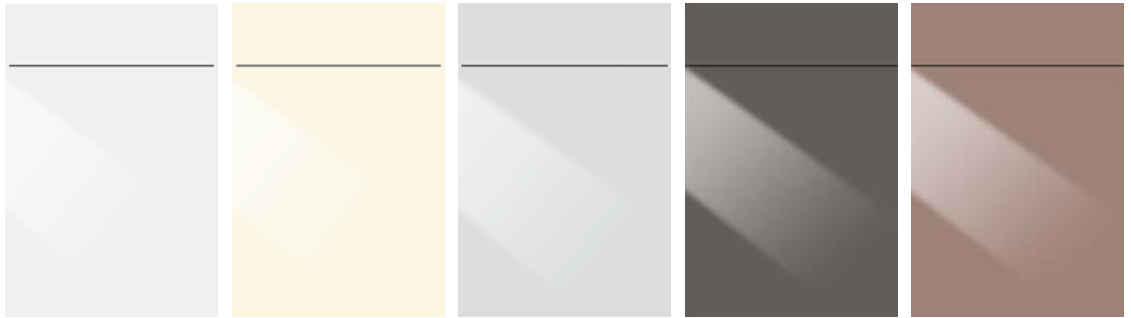

LAILA 380

**Weiß Hochglanz**  
White high-gloss  
Wit hoogglans  
Blanc brillant

LAILA 383

**Silk Hochglanz**  
Silk high-gloss  
Silk hoogglans  
Silk brillant

LAILA 384

**Moonlight grey Hochglanz**  
Moonlight grey high-gloss  
Moonlight grey hoogglans  
Moonlight grey brillant

LAILA 385

**Quarzgrau Hochglanz**  
Quartz grey high-gloss  
Kwartsgrijs hoogglans  
Gris quartz brillant

LAILA 387

**Greige Hochglanz**  
Greige high-gloss  
Greige hoogglans  
Grège brillant

LAILA



#### *IN GROTE HELDERHEID*

De strak vormgegeven designkeukens LARA en LAILA overtuigen met hun pure esthetiek. Met of zonder grepen, met bijpassende zichtzijden of uitgevoerd in accentkleuren – de hoogwaardige frontlak weerspiegelt klasse en aspiratie. U heeft de keuze tussen LARA in een elegante zijdematte lakafwerking en LAILA, die in het oog springt met een prestigieus hoogglanzend gelakt front.

#### *D'UNE GRANDE CLARTÉ*

Grâce à leurs lignes épurées, les cuisines LARA et LAILA séduisent par les traits fins et délicats de leur design. Avec ou sans poignée, avec des côtés visibles assortis ou des contrastes frappants, les façades laquées exclusives reflètent la classe et l'élégance. Vous avez le choix entre LARA qui se distingue par ses façades laquées mat soyeux et LAILA dont les façades laquées brillant attirent tous les regards.



# CINDY

STORMGREY SEIDENMATT/  
ALMOST BLUE SEIDENMATT







CELINE

CONCRETE GREY

JETTE

SCHWARZ SEIDENMATT



**Außergewöhnliche Dimensionen:  
Neue Pult- und Thekenplatten  
in 90 mm setzen ein markantes  
Zeichen in der modernen Küche.**

Dimensions beyond the norm: new bar and counter tops in 90 mm make a mark of distinction in the modern kitchen.

Buitengewone dimensies: nieuwe dikke werkbladen en barbladen van 90 mm brengen opvallende accenten aan in de moderne keuken.

Dimensions exceptionnelles : les nouveaux plans de travail épais et comptoirs, 90 mm d'épaisseur, sont un signe particulier de la cuisine moderne.

# PULT- UND THEKENPLATTEN

**90 MM**

BAR AND COUNTER TOPS 90 MM  
DIKKE WERKBLADEN & BARBLADEN 90 MM  
PLANS DE TRAVAIL ÉPAIS ET COMPTOIRS 90 MM



**882 Grain hell**  
882 Grain light  
882 Grain licht  
882 Grain clair



**889 Concrete grey**



**891 Grain Cognac**



**893 Arizona Pine**



**898 Concrete anthracite**



**937 Historic Oak**



**941 Black burned**



**942 Natural Oak**



**953 Alpine Oak**



**956 Elegant brown**



**957 Saloon**



**961 Skyfall**



**967 Wild Oak**



**969 Marmor Grigio**



**970 Marmor Bianco**

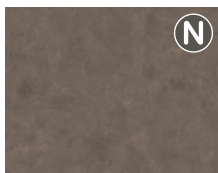

**973 Terra**

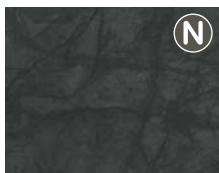

**978 Marmor Nero**

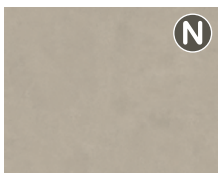

**979 Sand**  
979 Zand



**981 Honey Oak**

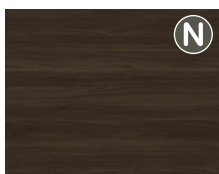

**982 Coffee Oak**

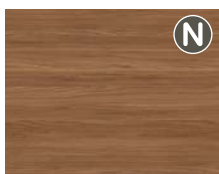

**983 Amber Oak**



AMELIE

KITO STAHL

SUSANN

POLARWEISS HOCHGLANZ









*COMFORT TOT IN DETAIL*

Uittrekbare plateaus en  
slimme relingsystemen -  
goede ideeën die het  
verschil maken.

*COMFORT JUSQUE DANS  
LES MOINDRES DÉTAILS*

Tablettes escamotables  
et rambardes judicieuses -  
ce sont ces bonnes idées  
qui font la différence.

# KOMFORT

## BIS INS DETAIL

**Herausziehbare Tablarböden  
und pfiffige Relingsysteme -  
es sind gute Ideen, die den  
Unterschied machen.**

*CONVENIENCE IN EVERY DETAIL*

Pull-out shelves and clever  
railing systems - it's good ideas  
that make the difference.



*FRESH INSPIRATION  
FRISSE INSPIRATIE  
INSPIRATION FRAÎCHEUR*

# FRISCHE INSPIRATION



NISCHENMOTIVE | RECESS MOTIFS  
 NISMOTIEVEN | MOTIFS CRÉDENCE



FG 643  
**Pustoblume**  
 Dandelion  
 Paardenbloem  
 Pissenlit



FG 653  
**Gewürze**  
 Spices  
 Kruiden  
 Épices



FG 651  
**Strand**  
 Beach  
 Strand  
 Plage

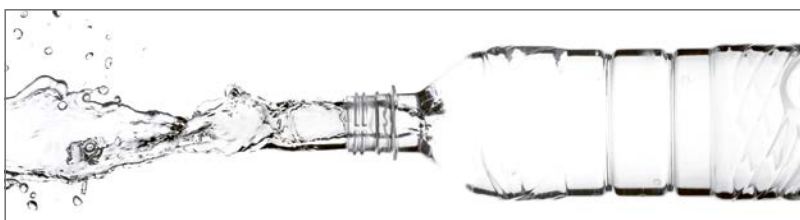

FG 623  
**Water**



FG 626  
**Fliesenoptik**  
 Tiled look  
 Tegel-look  
 Aspect carrelage

FG 647  
**Antico**



FG 654  
**Beton**  
 Concrete  
 Beton  
 Béton



FG 639  
**Kräuter**  
 Herbs  
 Kruiden  
 Herbes aromatiques



FG 652  
**Aquarell**  
 Watercolour  
 Aquarel  
 Aquarelle



TAFELLACK Blackboard paint Tafellak Gomme-laque

NISCHENMOTIVE  
 RECESS MOTIFS  
 NISMOTIEVEN  
 MOTIFS CRÉDENCE



104 SATINATO

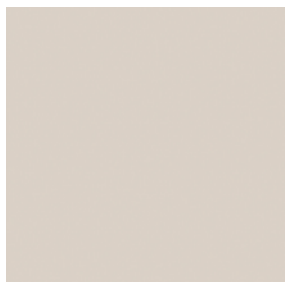

327 SANDBEIGE  
 Sand beige  
 Zandbeige  
 Beige sable

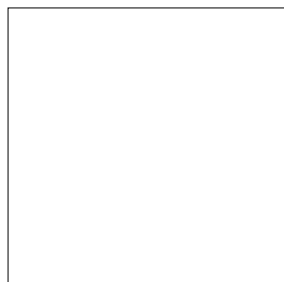

379 WEISS  
 White  
 Wit  
 Blanc

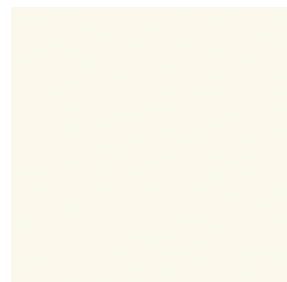

442 SILK

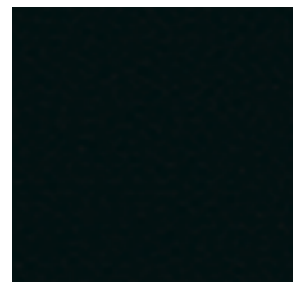

342 SCHWARZ  
 Black  
 Zwart  
 Noir



FG 655

**Goldene Linien**  
Golden Lines  
Gouden lijnen  
Lignes dorées

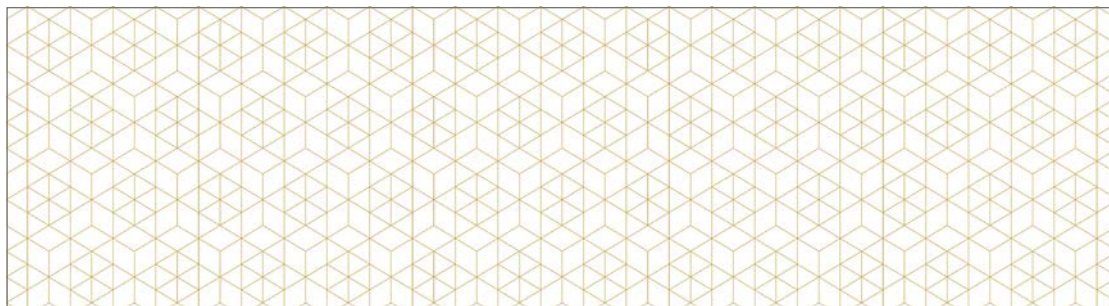

FG 657

**Birkenwald**  
Birch forest  
Berkenbos  
Forêt de bouleaux



FG 659

**Kakteen**  
Cacti  
Cactussen  
Cactus



FG 656

**Bätter**  
Leaves  
Gebladerte  
Feuillage

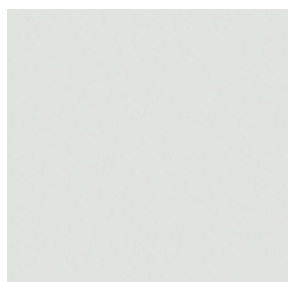

434 MOONLIGHT GREY



FG 658

**Palmen**  
Palm trees  
Palmen  
Palmiers

FRONTEN | FRONT PANELS | FRONTEN | FAÇADES

PG  
1

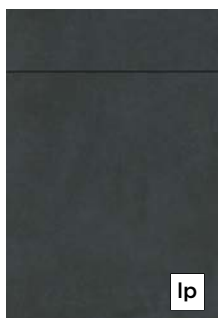

AMELIE 155  
**Kito Stahl**  
Kito steel  
Kito staal  
Kito acier

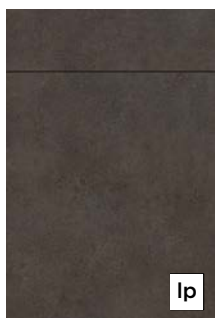

AMELIE 157  
**Mocca**

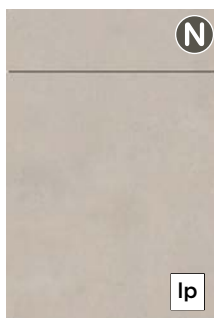

AMELIE 158  
**Sand**  
Zand

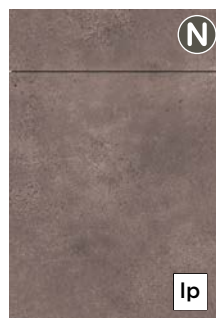

AMELIE 159  
**Terra**



ANNA 147  
**Black burned**



ANNA 149  
**Natural Oak**

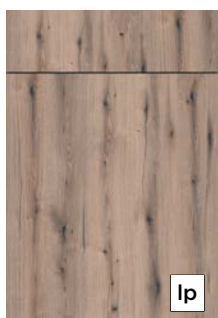

ANNA 161  
**Alpine Oak**



CARLA 166  
**Weiß Perlstruktur**  
White pearl texture  
Wit parelstructuur  
Blanc structure perlée



CARLA 179  
**Magnolie**  
Magnolia  
Magnolia  
Magnolia



CELINE 126  
**Concrete grey**



CELINE 132  
**Concrete white**



CELINE 134  
**Concrete anthracite**



CINDY 230  
**Almost blue seidenmatt**  
Almost blue silky matt  
Almost blue zijdemat  
Almost blue mat soyeux

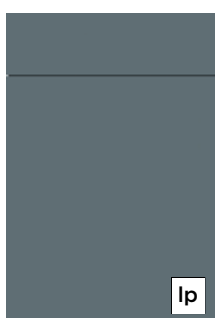

CINDY 233  
**Stormgrey seidenmatt**  
Stormgrey silky matt  
Stormgrey zijdemat  
Stormgrey mat soyeux



CINDY 234  
**Greige**  
Greige  
Greige  
Gréige

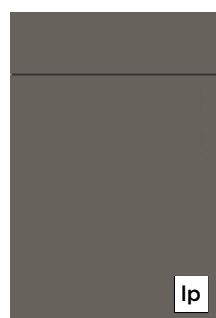

CINDY 235  
**Quarzgrau**  
Quartz grey  
Kwartsgrijs  
Gris quartz



CINDY 237  
**Salbei seidenmatt**  
Sage silky matt  
Salie zijdemat  
Sauge mat soyeux

**lp** linea piantra:  
Grifflos erhältlich  
Available without handles  
Greeploos verkrijgbaar  
Disponible sans poignées

# FRONTEN | FRONT PANELS | FRONTEN | FAÇADES

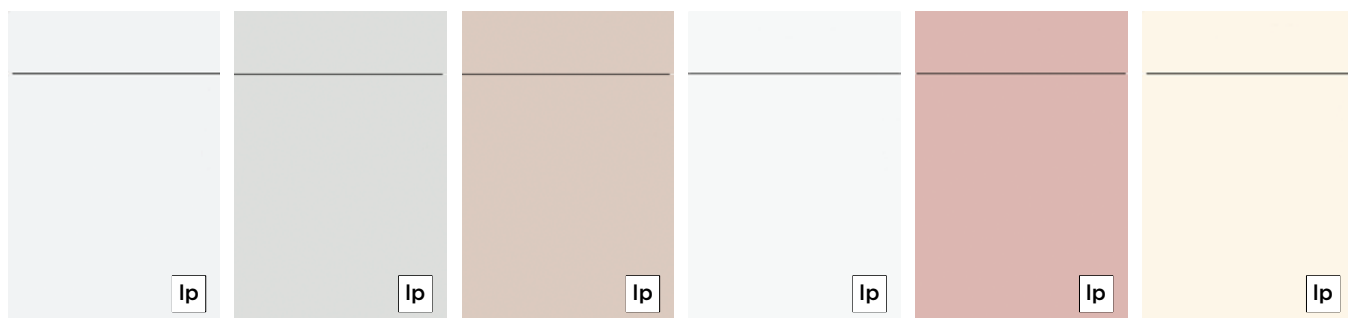

CINDY 239  
**Weiß seidenmatt**  
 White silky matt  
 Wit zijdemat  
 Blanc mat soyeux

CINDY 240  
**Moonlight grey seidenmatt**  
 Moonlight grey silky matt  
 Moonlight grey zijdemat  
 Moonlight grey mat soyeux

CINDY 241  
**Sandbeige seidenmatt**  
 Sand beige silky matt  
 Zandbeige zijdemat  
 Beige sable mat soyeux

CINDY 245  
**Polarweiß seidenmatt**  
 Polar white silky matt  
 Polarwit zijdemat  
 Blanc polaire mat soyeux

CINDY 246  
**Marshmallow seidenmatt**  
 Marshmallow silky matt  
 Marshmallow zijdemat  
 Marshmallow mat soyeux

CINDY 248  
**Silk seidenmatt**  
 Silk silky matt  
 Silk zijdemat  
 Silk mat soyeux

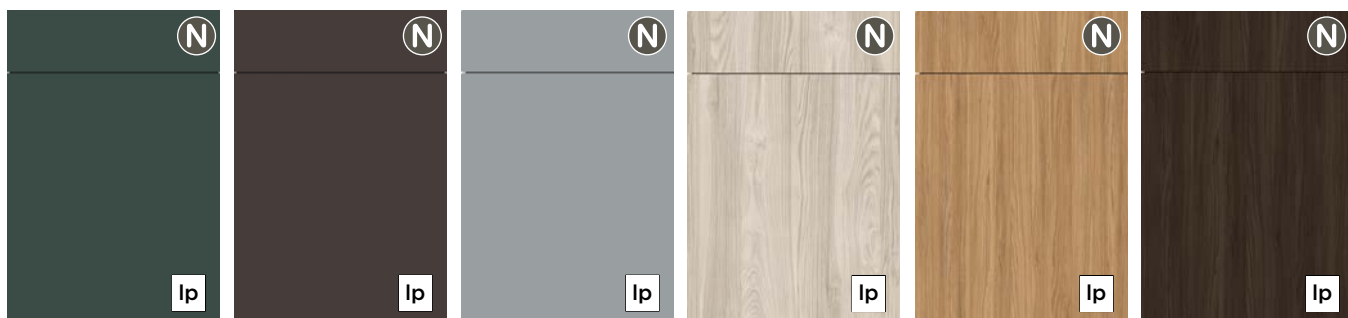

CINDY 252  
**Black green seidenmatt**  
 Black green silky matt  
 Black green zijdemat  
 Black green mat soyeux

CINDY 254  
**Intense brown seidenmatt**  
 Intense brown silky matt  
 Intense brown zijdemat  
 Intense brown mat soyeux

CINDY 255  
**Nebelgrau seidenmatt**  
 Mist grey silky matt  
 Mist grijs zijdemat  
 Gris brume mat soyeux

CORA 140  
**Shell Oak**

CORA 141  
**Honey Oak**

CORA 143  
**Coffee Oak**



CORA 145  
**Wild Oak**

CORA 171  
**Eiche Sand**  
 Oak sand  
 Eiken zand,  
 Chêne sable

CORA 185  
**Grain hell**  
 Grain light  
 Grain licht  
 Grain clair

LENI 188  
**Soft Groove**

LENI 189  
**Dark Groove**

**linea piantra:**   
 Grifflos erhältlich  
 Available without handles  
 Greeploos verkrijgbaar  
 Disponible sans poignées

FRONTEN | FRONT PANELS | FRONTEN | FAÇADES

PG  
2



ANABELLE 201  
Black burned



ANABELLE 202  
Natural Oak



ANABELLE 203  
Alpine Oak

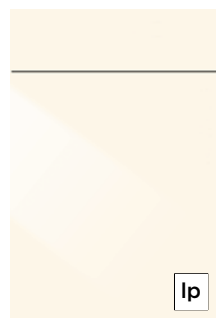

DIANA 194  
Silk glänzend  
Silk gloss  
Silk glanzend  
Silk brillant

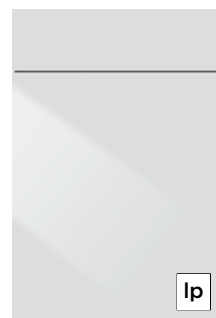

DIANA 195  
Moonlight grey glänzend  
Moonlight grey gloss  
Moonlight grey glanzend  
Moonlight grey brillant

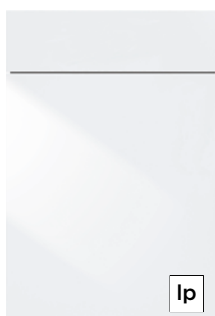

DIANA 200  
Weiß glänzend  
White gloss  
Wit glanzend  
Blanc brillant



JETTE 275  
Weiß seidenmatt  
White silky matt  
Wit zijdemat  
Blanc mat soyeux

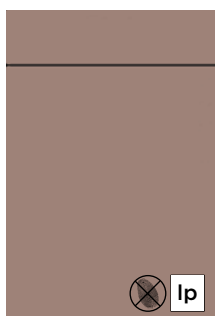

JETTE 276  
Greige seidenmatt  
Greige silky matt  
Greige zijdemat  
Grège mat soyeux

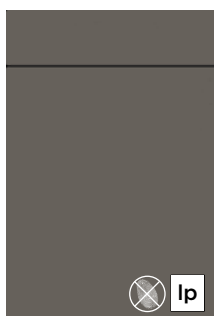

JETTE 277  
Quarzgrau seidenmatt  
Quartz grey silky matt  
Kwartsgrijs zijdemat  
Gris quartz mat soyeux

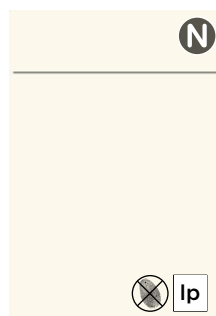

JETTE 278  
Silk seidenmatt  
Silk silky matt  
Silk zijdemat  
Silk mat soyeux



JETTE 279  
Schwarz seidenmatt  
Black silky matt  
Zwart zijdemat  
Noir mat soyeux

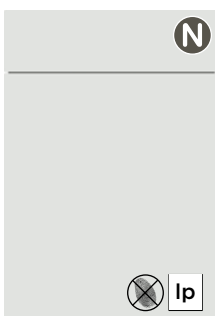

JETTE 280  
Moonlight grey seidenmatt  
Moonlight grey silky matt  
Moonlight grey zijdemat  
Moonlight grey mat soyeux

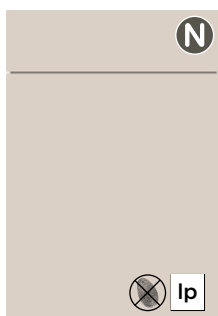

JETTE 281  
Sandbeige seidenmatt  
Sand beige silky matt  
Zandbeige zijdemat  
Beige sable mat soyeux

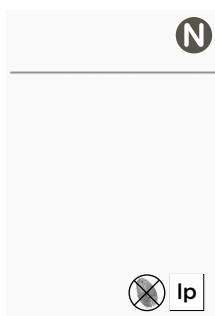

JETTE 282  
Polarweiß seidenmatt  
Polar white silky matt  
Polarwit zijdemat  
Blanc polaire mat soyeux

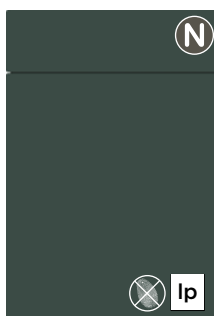

JETTE 286  
Black green seidenmatt  
Black green silky matt  
Black green zijdemat  
Black green mat soyeux

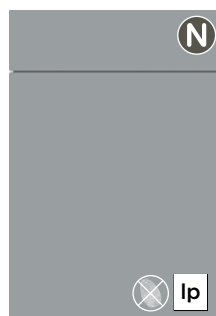

JETTE 287  
Nebelgrau seidenmatt  
Mist grey silky matt  
Mist grijs zijdemat  
Gris brume mat soyeux

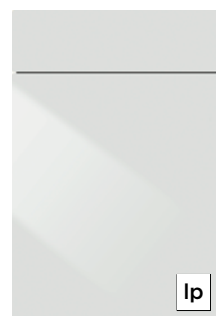

SUSANN 265  
Moonlight grey Hochglanz  
Moonlight grey high-gloss  
Moonlight grey hoogglans  
Moonlight grey brillant

**lp** linea piantra:  
Grifflos erhältlich  
Available without handles  
Greeploos verkrijgbaar  
Disponible sans poignées

**X** Anti-Fingerprint  
Anti-fingerprint  
Anti-fingerprint  
Anti-traces de doigts

FRONTEN | FRONT PANELS | FRONTEN | FAÇADES

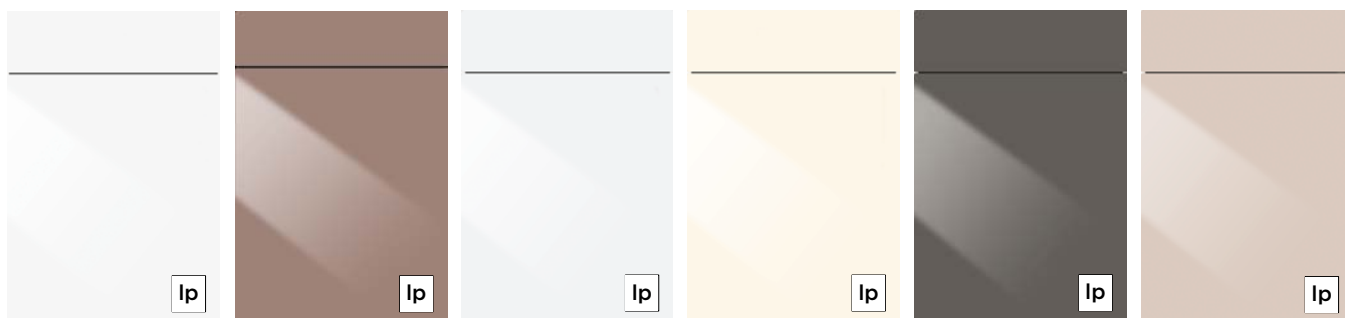

SUSANN 268

**Polarweiß Hochglanz**  
Polar white high-gloss  
Polarwit hoogglans  
Blanc polaire brillant

SUSANN 294

**Greige Hochglanz**  
Greige high-gloss  
Greige hoogglans  
Grège brillant

SUSANN 296

**Weiß Hochglanz**  
White high-gloss  
Wit hoogglans  
Blanc brillant

SUSANN 297

**Silk Hochglanz**  
Silk high-gloss  
Silk hoogglans  
Silk brillant

SUSANN 298

**Quarzgrau Hochglanz**  
Quartz grey high-gloss  
Kwartsgrijs hoogglans  
Gris quartz brillant

SUSANN 299

**Sandbeige Hochglanz**  
Sand beige high-gloss  
Zandbeige hoogglans  
Beige sable brillant

PG  
3

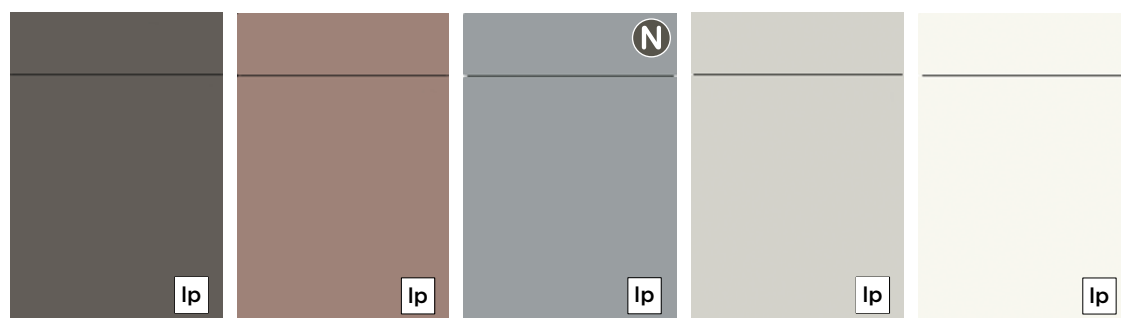

LARA 356

**Quarzgrau seidenmatt**  
Quartz grey silky matt  
Kwartsgrijs zijdemat  
Gris quartz mat soyeux

LARA 357

**Greige seidenmatt**  
Greige silky matt  
Greige zijdemat  
Grège mat soyeux

LARA 358

**Nebelgrau seidenmatt**  
Mist grey silky matt  
Mist grijs zijdemat  
Gris brume mat soyeux

LARA 389

**Moonlight grey seidenmatt**  
Moonlight grey silky matt  
Moonlight grey zijdemat  
Moonlight grey mat soyeux

LARA 391

**Weiß seidenmatt**  
White silky matt  
Wit zijdemat  
Blanc mat soyeux

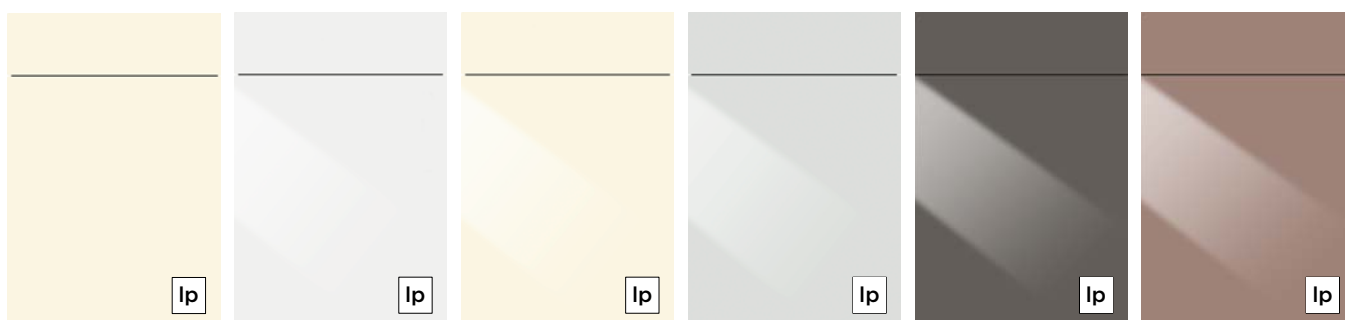

LARA 392

**Silk seidenmatt**  
Silk silky matt  
Silk zijdemat  
Silk mat soyeux

LARA 380

**Weiß Hochglanz**  
White high-gloss  
Wit hoogglans  
Blanc brillant

LARA 383

**Silk Hochglanz**  
Silk high-gloss  
Silk hoogglans  
Silk brillant

LARA 384

**Moonlight grey Hochglanz**  
Moonlight grey high-gloss  
Moonlight grey hoogglans  
Moonlight grey brillant

LARA 385

**Quarzgrau Hochglanz**  
Quartz grey high-gloss  
Kwartsgrijs hoogglans  
Gris quartz brillant

LARA 387

**Greige Hochglanz**  
Greige high-gloss  
Greige hoogglans  
Grège brillant

**linea piantra:**   
Grifflos erhältlich  
Available without handles  
Greploos verkrijgbaar  
Disponibile sans poignées

FRONTEN | FRONT PANELS | FRONTEN | FAÇADES



**MARA 435**  
**Sandbeige seidenmatt**  
 Sand beige silky matt  
 Zandbeige zijdemat  
 Beige sable mat soyeux



**MARA 436**  
**Moonlight grey seidenmatt**  
 Moonlight grey silky matt  
 Moonlight grey zijdemat  
 Moonlight grey mat soyeux



**MARA 437**  
**Salbei seidenmatt**  
 Sage silky matt  
 Salie zijdemat  
 Sauge mat soyeux



**MARA 438**  
**Silk seidenmatt**  
 Silk silky matt  
 Silk zijdemat  
 Silk mat soyeux



**MARA 439**  
**Weiß seidenmatt**  
 White silky matt  
 Wit zijdemat  
 Blanc mat soyeux



**MARA 446**  
**Quarzgrau seidenmatt**  
 Quartz grey silky matt  
 Kwartzgrijs zijdemat  
 Gris quartz mat soyeux



**MARA 448**  
**Schwarz seidenmatt**  
 Black silky matt  
 Zwart zijdemat  
 Noir mat soyeux



**MARA 449**  
**Greige seidenmatt**  
 Greige silky matt  
 Greige zijdemat  
 Grège mat soyeux

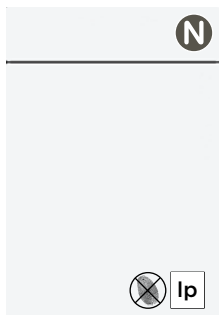

**PAULA 331**  
**Weiß seidenmatt**  
 White silky matt  
 Wit zijdemat  
 Blanc mat soyeux

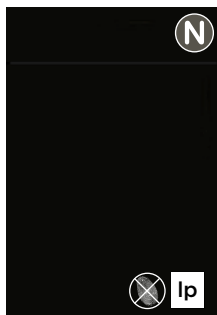

**PAULA 332**  
**Schwarz seidenmatt**  
 Black silky matt  
 Zwart zijdemat  
 Noir mat soyeux

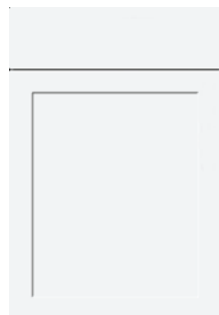

**SOPHIE 370**  
**Weiß seidenmatt**  
 White silky matt  
 Wit zijdemat  
 Blanc mat soyeux

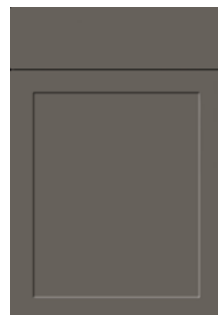

**SOPHIE 371**  
**Quarzgrau seidenmatt**  
 Quartz grey silky matt  
 Kwartzgrijs zijdemat  
 Gris quartz mat soyeux



**SOPHIE 372**  
**Silk seidenmatt**  
 Silk silky matt  
 Silk zijdemat  
 Silk mat soyeux



**SOPHIE 373**  
**Greige seidenmatt**  
 Greige silky matt  
 Greige zijdemat  
 Grège mat soyeux

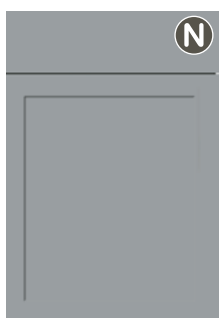

**SOPHIE 374**  
**Nebelgrau seidenmatt**  
 Mist grey silky matt  
 Mist grijs zijdemat  
 Gris brume mat soyeux

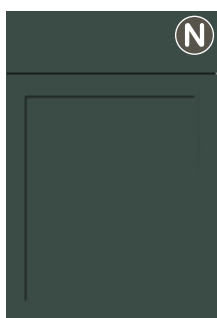

**SOPHIE 375**  
**Black green seidenmatt**  
 Black green silky matt  
 Black green zijdemat  
 Black green mat soyeux

PG  
5



**TESSA 351**  
**Weiß Hochglanz**  
 White high-gloss  
 Wit hoogglans  
 Blanc brillant

**Ip** **linea piantra:**  
 Grifflos erhältlich  
 Available without handles  
 Greeploos verkrijgbaar  
 Disponible sans poignées

 **Anti-Fingerprint**  
 Anti-fingerprint  
 Anti-fingerprint  
 Anti-traces de doigts





**106 Magnolie**  
106 Magnolia  
106 Magnolia  
106 Magnolia



**107 Eiche Sand**  
107 Oak sand  
107 Eiken zand  
107 Chêne sable



**116 Weiß**  
116 White  
116 Wit  
116 Blanc



**119 Grain hell**  
119 Grain light  
119 Grain licht  
119 Grain clair



**124 Wild Oak**

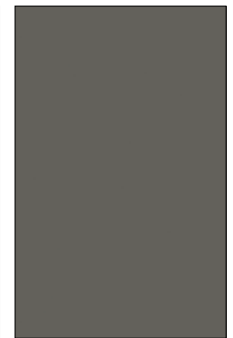

**126 Quarzgrau**  
126 Quartz grey  
126 Kwartsgrijs  
126 Gris quartz

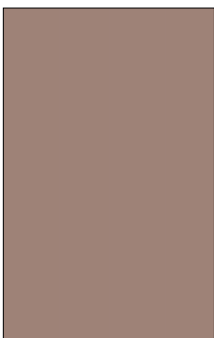

**127 Greige**



**131 Natural Oak**

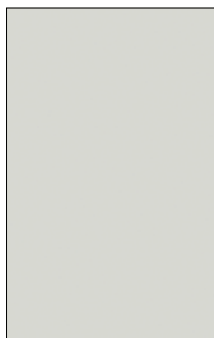

**142 Moonlight grey seidenmatt**  
142 Moonlight grey silky matt  
142 Moonlight grey zijdemat  
142 Moonlight grey mat soyeux

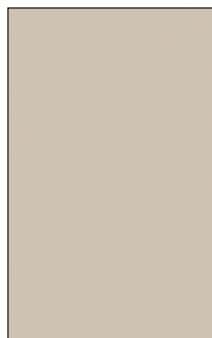

**143 Sandbeige seidenmatt**  
143 Sand beige silky matt  
143 Zandbeige zijdemat  
143 Beige sable mat soyeux

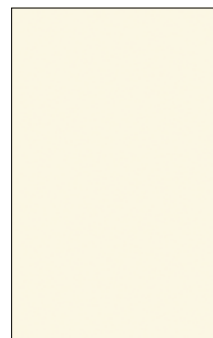

**146 Silk seidenmatt**  
146 Silk silky matt  
146 Silk zijdemat  
146 Silk mat soyeux

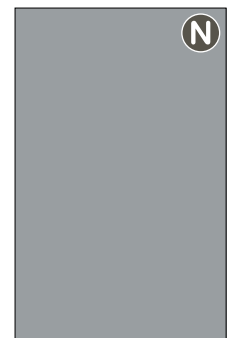

**125 Nebelgrau seidenmatt**  
125 Mist grey silky matt  
125 Mist grijs zijdemat  
125 Gris brume mat soyeux

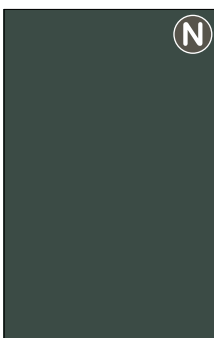

**118 Black green seidenmatt**  
118 Black green silky matt  
118 Black green zijdemat  
118 Black green mat soyeux



**134 Shell Oak**



**135 Honey Oak**



**136 Coffe Oak**



**115 Schwarz**  
115 Black  
115 Zwart  
115 Noir

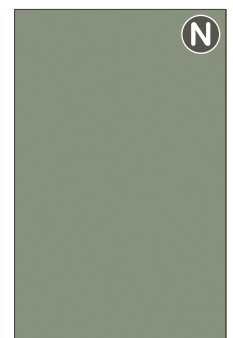

**114 Salbei seidenmatt**  
114 Sage silky matt  
114 Salie zijdemat  
114 Sauge mat soyeux



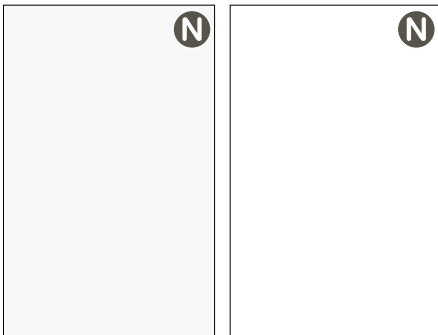

**145 Polarweiß seidenmatt**  
 145 Polar white silky matt  
 145 Polarwit zijdemat  
 145 Blanc polaire mat  
 soyeux

**113 Weiß seidenmatt**  
 113 White silky matt  
 113 Wit zijdemat  
 113 Blanc mat soyeux

SICHTSEITEN | VISIBLE SIDES | ZICHTBARE ZIJDEN | CÔTÉS VISIBLES



**588 Concrete grey**

**589 Concrete white**

**596 Concrete anthracite**

**177 Weiß glänzend**  
 177 White gloss  
 177 Wit glanzend  
 177 Blanc brillant

**727 Sandbeige glänzend**  
 727 Sand beige gloss  
 727 Zandbeige glanzend  
 727 Beige sable brillant

**728 Moonlight grey glänzend**  
 728 Moonlight grey gloss  
 728 Moonlight grey glanzend  
 728 Moonlight grey brillant

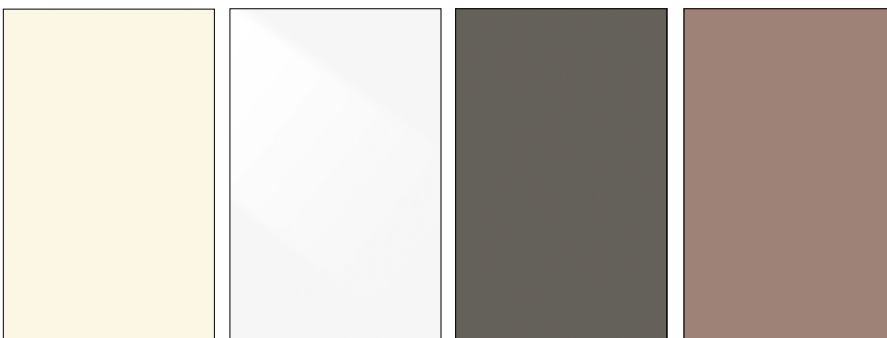

**729 Silk glänzend**  
 729 Silk gloss  
 729 Silk glanzend  
 729 Silk brillant

**735 Polarweiß glänzend**  
 735 Polar white gloss  
 735 Polarwit glanzend  
 735 Blanc polaire brillant

**738 Quarzgrau glänzend**  
 738 Quartz grey gloss  
 738 Kwartsgrijs glanzend  
 738 Gris quartz brillant

**742 Greige glänzend**  
 742 Greige white  
 742 Greige glanzend  
 742 Grège brillant

ARBEITSPLATTEN 16, 25 UND 39 MM | WORKTOPS 16, 25 AND 39 MM  
 WERKBLADEN 16, 25 EN 39 MM | PLANS DE TRAVAIL 16, 25 ET 39 MM



865 Ceramica



869 Eiche Sand  
 869 Oak sand  
 869 Eiken zand  
 869 Chêne sable



882 Grain hell  
 882 Grain light  
 882 Grain licht  
 882 Grain clair



883 Rock Kiesel  
 883 Rock pebble  
 883 Rock kiezel  
 883 Rock gravier



889 Concrete grey



890 Concrete white



891 Grain Cognac



893 Arizona Pine



898 Concrete anthracite



937 Historic Oak



941 Black burned



942 Natural Oak



947 Atlantic Stone Steel



952 Ulme gekälkt  
 952 Elm limed  
 952 Olm gekalkt  
 952 Orme blanchi



953 Alpine Oak



956 Elegant brown



957 Saloon



960 Kito Stahl  
 960 Kito steel  
 960 Kito staal  
 960 Kito acier

ARBEITSPLATTEN 16, 25 UND 39 MM | WORKTOPS 16, 25 AND 39 MM  
WERKBLADEN 16, 25 EN 39 MM | PLANS DE TRAVAIL 16, 25 ET 39 MM



961 Skyfall



962 Mocca



964 Tibet



965 Quarz Rose



966 Stone Grid



967 Wild Oak



969 Marmor Grigio



970 Marmor Bianco



971 Moon



973 Terra



976 Green Slade



978 Marmor Nero

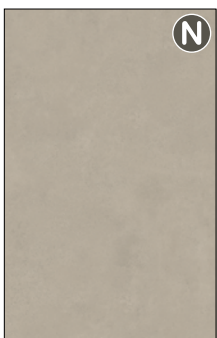

979 Sand  
979 Zand



980 Shell Oak



981 Honey Oak



982 Coffee Oak



983 Amber Oak

PULT- & THEKENPLATTEN 90 MM | BAR AND COUNTER TOPS 90 MM  
 DIKKE WERKBLADEN & BARBLADEN 90 MM  
 PLANS DE TRAVAIL ÉPAIS ET COMPTOIRS 90 MM



**882 Grain hell**  
 882 Grain light  
 882 Grain licht  
 882 Grain clair

**889 Concrete grey**

**891 Grain Cognac**

**893 Arizona Pine**

**898 Concrete anthracite**

**937 Historic Oak**



**941 Black burned**

**942 Natural Oak**

**953 Alpine Oak**

**956 Elegant brown**

**957 Saloon**

**961 Skyfall**



**967 Wild Oak**

**969 Marmor Grigio**

**970 Marmor Bianco**

**973 Terra**

**978 Marmor Nero**

**979 Sand**  
 979 Zand

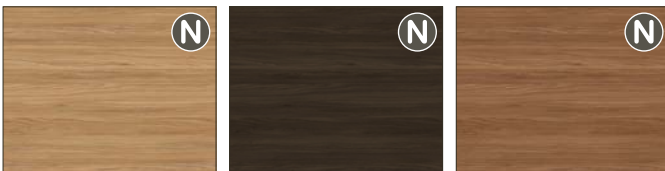

**981 Honey Oak**

**982 Coffee Oak**

**983 Amber Oak**

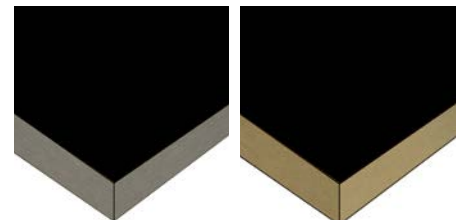

**Kante**  
 edge  
 kant  
 chant

**Kante**  
 edge  
 kant  
 chant

**FG 154 Edelhloptik**  
 FG 154 Stainless-steel look  
 FG 154 roestvrij staal-look  
 FG 154 Aspect inox

**FG 155 Messingoptik**  
 FG 155 Brass look  
 FG 155 messing-look  
 FG 155 Aspect laiton

GRIFFLEISTEN LINEA PIANTRA | LINEA PIANTRA FINGER PULLS  
 GREEPLIJSTEN LINEA PIANTRA | POIGNÉES PROFIL LINEA PIANTRA



**FG 399**  
**Edelstahlfarbig**  
 Stainless steel coloured  
 Rvs-kleur  
 Couleur inox

**FG 420**  
**Weiß gepulvert**  
 White, powder-coated  
 wit poedercoating  
 Blanc, poudre époxy

**FG 421**  
**Moonlight grey gepulvert**  
 Moonlight grey, powder-coated  
 Moonlight grey poedercoating  
 Moonlight grey, poudre époxy

**FG 422**  
**Quarzgrau gepulvert**  
 Quartz grey, powder-coated  
 kwartsgrijs poedercoating  
 Gris quartz, poudre époxy

**FG 424**  
**Polarweiß gepulvert**  
 Polar white, powder-coated  
 poolwit poedercoating  
 Blanc polaire, poudre époxy

**FG 456**  
**Schwarz gepulvert**  
 Black, powder-coated  
 zwart poedercoating  
 Noir, poudre époxy

GRIFFE | HANDLES | GREPEN | POIGNÉES



Nr. 118

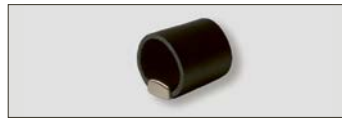

Nr. 316



Nr. 606



Nr. 121



Nr. 401



Nr. 613



Nr. 122



Nr. 511



Nr. 646



Nr. 123



Nr. 512



Nr. 666



Nr. 124



Nr. 513



Nr. 673



Nr. 125



Nr. 514



Nr. 677



Nr. 126



Nr. 515



Nr. 702



Nr. 127



Nr. 602

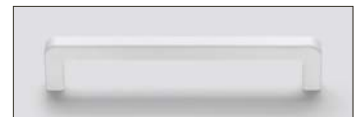

Nr. 706



Nr. 128



Nr. 603



Nr. 715

GRIFFE | HANDLES | GREPEN | POIGNÉES

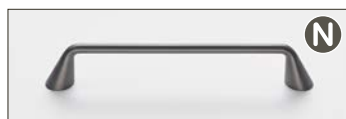

Nr. 716



Nr. 736



Nr. 754



Nr. 720



Nr. 737



Nr. 755



Nr. 721



Nr. 738



Nr. 761



Nr. 722



Nr. 739



Nr. 769



Nr. 723



Nr. 741

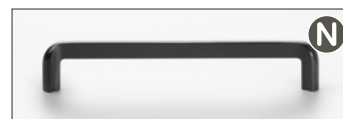

Nr. 786



Nr. 724



Nr. 743

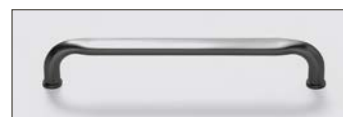

Nr. 787



Nr. 725



Nr. 745



Nr. 788



Nr. 728



Nr. 751

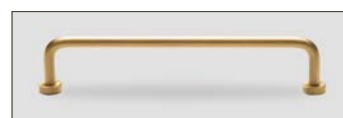

Nr. 790



Nr. 731



Nr. 752



Nr. 791



Nr. 796



Nr. 224



Nr. 228



Nr. 802



Nr. 225



Nr. 276



Nr. 202



Nr. 226



Nr. 230



Nr. 222



Nr. 227



Nr. 250



Nr. 242



Nr. 253



Nr. 278



Nr. 243



Nr. 254



Nr. 298



Nr. 252



Nr. 255



**VIRTUELLER SHOWROOM**

VIRTUAL SHOWROOM  
VIRTUELE SHOWROOM  
SHOWROOM VIRTUEL



**ONLINE-KATALOG**

ONLINE CATALOGUE  
ONLINE CATALOGUS  
CATALOGUE EN LIGNE



**Burger Küchenmöbel GmbH**

Martin-Luther-Straße 31 · 39288 Burg  
T +49 3921 976-0  
F +49 3921 976-228

info@burger-kuechen.de · burger-kuechen.de